



# Digital Receipt

This receipt acknowledges that Turnitin received your paper. Below you will find the receipt information regarding your submission.

The first page of your submissions is displayed below.

Submission author: Turnitin Instructor  
Assignment title: Plagiasi Jurnal Teknik 2  
Submission title: Load Sharing and Voltage Restoration Improvement in DC M...  
File name: vement\_in\_DC\_Microgrids\_with\_Adaptive\_Droop\_Control\_Str...  
File size: 1.36M  
Page count: 8  
Word count: 5,318  
Character count: 27,435  
Submission date: 16-Mar-2024 11:05PM (UTC+0700)  
Submission ID: 2321976477

  
International Journal on Engineering Applications (I.R.E.A), Vol.10, N.4  
ISSN 2287-2801 July 2022

**Load Sharing and Voltage Restoration Improvement  
in DC Microgrids with Adaptive Droop Control Strategy**

Machmud Effendy<sup>1,2</sup>, Mochamad Ashari<sup>1\*</sup>, Heri Suryoatmojo<sup>1</sup>

**Abstract** – DC microgrid is a connecting network between distributed DC generators. The converter control on DCMG is used to obtain proportional load sharing and voltage restoration of DC bus. The traditional droop control is a common control technique in DC microgrid networks with multiple unit converters. However, this technique has limited performance when the difference of the line resistance is considered. In this paper, the intelligent adaptive droop control is proposed to improve the accuracy of load sharing, while the distributed secondary loop is utilized to minimize the DC bus voltage deviation. The droop resistance is tuned using fuzzy logic controller so that the load power sharing error compensation is obtained, while the DC bus voltage deviation is reduced by the PI controller. The exchange of output currents between converter units through communication lines is considered to obtain the actual load current conditions. The proposed droop control strategy can guarantee the load power sharing balance between three sources with a ratio close to 1:1:1. The results of the comparison analysis between the proposed technique and the traditional droop control are simulated completely using Matlab/Simulink, even under fluctuating loads and the line resistance changes. Copyright © 2022 Praise Worthy Prize S.r.l. – All rights reserved.

**Keywords:** Fuzzy Logic, Load Sharing, Droop Control, DC Microgrid

---

**Nomenclature**

DCMG	DC microgrid
DCG	DC generator
PI	Proportional integrator
FLC	Fuzzy logic controller
$V_d$	DC voltage source (V)
$V_{dc}$	Input voltage of converter (V)
$V_{out}$	Output voltage of converter (V)
$i_c$	Output current of converter (A)
$i_{avg}$	Average output current of all converter (A)
$R_d$	Droop resistance ( $\Omega$ )
$V_{bus}$	DC bus voltage (V)
$V_{bus,ref}$	DC bus voltage reference (V)
$R_{line}$	Line resistance ( $\Omega$ )
$V_{max}$	Maximum allowable voltage deviation (V)
$V_{th}$	Voltage threshold (V)
$K_p$	Proportional gain
$K_i$	Integral gain
$\delta v$	Voltage deviation compensation
$\beta R_D$	Resistance droop coefficient
$L_c$	Converter inductance (H)
$C_c$	Converter capacitance (F)
$f_s$	Frequency switching (Hz)
$t$	Time (s)

**I. Introduction**

The role of microgrids is very important in smart grid as it offers several advantages, such as efficiency, reliability, and expandability [1,2]. DC microgrid (DCMG) system efficiency is better than AC microgrid, because DCMGs have no reactive power flow, skin effect, and frequency [3]. However, these advantages can only be realized if proper control mechanisms are used [4].

The dc-dc converter is the main device in the DCMG network. Several DC generators can share a load power proportionally through parallel DC-DC converters and DC buses as shown in Fig.1. The DC microgrid control system has a significant role to reduce the power sharing error between DC-DC converters and also to minimize the voltage drop on the dc bus [5,6]. Several methods for controlling DC microgrids have been developed in the literature, including the master-slave method and the droop techniques. By using the high bandwidth communication, the central controller in the master-slave method regulates the DC bus voltage from DCMG and transmits data to all the units so that the load power sharing is achieved [7-8]. The centralized control with the delay compensation technique is also used for power sharing between DC sources which can increase the

Copyright © 2022 Praise Worthy Prize S.r.l. – All rights reserved. <https://doi.org/10.15866/inea.v10i4.21483>

233

# Load Sharing and Voltage Restoration Improvement in DC Microgrids with Adaptive Droop Control Strategy

*by* Turnitin Instructor

---

**Submission date:** 16-Mar-2024 11:05PM (UTC+0700)

**Submission ID:** 2321976477

**File name:** vement\_in\_DC\_Microgrids\_with\_Adaptive\_Droop\_Control\_Strategy.pdf (1.36M)

**Word count:** 5318

**Character count:** 27435

## Load Sharing and Voltage Restoration Improvement in DC Microgrids with Adaptive Droop Control Strategy

Machmud Effendy<sup>1,2</sup>, Mochamad Ashari<sup>1\*</sup>, Heri Suryoatmojo<sup>1</sup>

**Abstract** – DC microgrid is a connecting network between distributed DC generators. The converter control on DCMG is used to obtain proportional load sharing and voltage restoration of DC bus. The traditional droop control is a common control technique in DC microgrid networks with multiple unit converters. However, this technique has limited performance when the difference of the line resistance is considered. In this paper, the intelligent adaptive droop control is proposed to improve the accuracy of load sharing, while the distributed secondary loop is utilized to minimize the DC bus voltage deviation. The droop resistance is tuned using fuzzy logic controller so that the load power sharing error compensation is obtained, while the DC bus voltage deviation is reduced by the PI controller. The exchange of output currents between converter units through communication lines is considered to obtain the actual load current conditions. The proposed droop control strategy can guarantee the load power sharing balance between three sources with a ratio close to 1:1:1. The results of the comparison analysis between the proposed technique and the traditional droop control are simulated completely using Matlab/Simulink, even under fluctuating loads and the line resistance changes. **Copyright © 2022 Praise Worthy Prize S.r.l. – All rights reserved.**

**Keywords:** Fuzzy Logic, Load Sharing, Droop Control, DC Microgrid

### Nomenclature

DCMG	DC microgrid
DCG	DC generator
PI	Proportional integrator
FLC	Fuzzy logic controller
$V_{dc}$	DC voltage source (V)
$V_{in}$	Input voltage of converter (V)
$V_{out}$	Output voltage of converter (V)
$i_c$	Output current of converter (A)
$\dot{i}_{c,avg}$	Average output current of all converter (A)
$R_d$	Droop resistance ( $\Omega$ )
$V_{bus}$	DC bus voltage (V)
$V_{bus,ref}$	DC bus voltage reference (V)
$R_{line}$	Line resistance ( $\Omega$ )
$V_{max}$	Maximum allowable voltage deviation (V)
$V_n$	Voltage threshold (V)
$K_p$	Proportional gain
$K_i$	Integral gain
$\delta v$	Voltage deviation compensation
$\Delta R_D$	Resistance droop coefficient
$L$	Converter inductance (H)
$C$	Converter capacitance (F)
$f_s$	Frequency switching (Hz)
$s$	Time (s)

### I. Introduction

The role of microgrids is very important in smart grid as it offers several advantages, such as efficiency, reliability, and expandability [1,2]. DC microgrid (DCMG) system efficiency is better than AC microgrid, because DCMGs have no reactive power flow, skin effect, and frequency [3]. However, these advantages can only be realized if proper control mechanisms are used [4].

The dc-dc converter is the main device in the DCMG network. Several DC generators can share a load power proportionally through parallel DC-DC converters and DC buses as shown in Fig.1. The DC microgrid control system has a significant role to reduce the power sharing error between DC-DC converters and also to minimize the voltage drop on the dc bus.[5,6]. Several methods for controlling DC microgrids have been developed in the literature, including the master-slave method and the droop techniques. By using the high bandwidth communication, the central controller in the master-slave method regulates the DC bus voltage from DCMG and transmits data to all the units so that the load power sharing is achieved [7-8]. The centralized control with the delay compensation technique is also used for power sharing between DC sources which can increase the

speed of the data transmission process [9-10]. On larger DC power grid systems, the centralized control can also simplify coordination between DC sources when a proportional sharing of load power is desired [11-13]. However, these systems have a single point failure as main drawback. In particular, the entire DC microgrid system will shut down when the central controller is disabled [14]. The droop control method has been widely used to keep the load proportional because all the local converters are controlled. Each converter in the droop control has two main parameters such as droop resistance and voltage reference [15,16]. The maximum droop resistance value is determined by the ratio between the highest allowable deviation voltage and the maximum load current of converter. The droop control has been widely utilized, but it has some drawbacks, such as high load power sharing error due to differences in transmission line resistance [17].

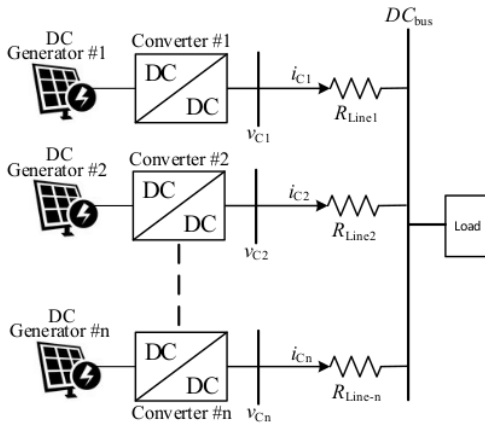

Fig. 1. Configuration system of DCMG With Parallel DC-DC Converter.

Some previous research has also studied a secondary control loop to reduce a voltage deviation by setting the reference voltage to the primary control, but it is unable to minimize the power sharing error [18,19]. [20] has proposed a decentralized control strategy utilizing DC bus signalling method for DC microgrids with renewable energy sources and energy storages. The operation of the PV generation and battery is highly dependent on the DC bus voltage level. In addition, local measurements with two-level hierarchical control method have been developed in [21]. This method eliminates the nominal voltage offset of the converters through the droop control. However, the impact of the transmission line resistance has not been tested in [20,21]. A droop control method with the secondary loop control has been proposed in [22]. In this technique, the output voltage of the converter is not affected by high droop resistance values and the influence of line resistance is taken into

account. However, the current exchange between converters is not considered, which makes the load power sharing not guaranteed. [23] has adopted an improved droop control method. By conventionally tuning the droop resistance of the droop controller, error in the power sharing between DC generators can be minimized. However, intelligent adaptive droop control has not been considered so the tuning droop resistance algorithm is more difficult as the number of converter units increases [4].

Therefore, in order to overcome this limitation, the automatic tuning of droop resistance using adaptive droop control based on fuzzy logic is proposed to obtain a more proportional distribution of load power. In addition, the low bandwidth communication of the distributed control is utilized in order to obtain the average current in each converter unit so that a better load power sharing can be achieved. The dynamic response of the proposed load power sharing methods is verified by using the Matlab simulink. Various disturbances are studied to demonstrate the potential of the offered methods.

The remainder of this paper includes four sections. Section II explains the droop control basic. Section III shows the proposed control method, which includes the primary control, the secondary control, and the intelligent adaptive droop method using fuzzy logic controllers. Then, the result of the test under different scenarios is presented in section IV. The test of the proposed strategy is on a low voltage DCMG under isolated operation, and the conclusion is presented in section V.

## II. The Droop Control Basic

When a droop control is utilized, DC distributed generators with power converter interfaces can be represented as an ideal voltage source and internal resistance. [24]. Fig.2 depicts the circuit model of two module DCMGs, where only two DCGs and one DC load are taken into account to simplify the analysis. Any line resistance difference causes unequal power sharing between the two power converters [25-27]. The following equation can be obtained from Fig.2 :

$$V_{dc,j} = V_{s,j} + i_j \cdot R_{d,j} \quad \text{where } j = 1,2 \quad (1)$$

Where  $V_{DCj}$ ,  $V_{sj}$ ,  $i_j$ , and  $R_{dj}$  are the nominal reference value of the DC voltage source, the output voltage of source power converter, the output current, and the droop resistances. Each droop resistance can be adjusted easily.

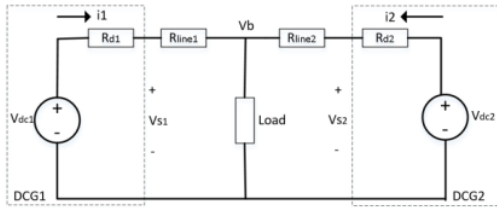

Fig. 2. Equivalent circuit of DCMG

Each power converter has an output voltage that can be calculated using (1):

$$V_{s,j} = V_b + i_j \cdot R_{line,j} \quad (2)$$

$V_b$  is the DC bus voltage and  $R_{line}$  is the transmission line resistance. Then the output current can be deduced, and specified by:

$$i_j = (V_{dc,j} - V_b) / (R_{d,j} + R_{line,j}) \quad (3)$$

Meanwhile, the DC bus voltage deviation is determined according to the difference  $V_{dc,j}$  and  $V_{s,j}$ :

$$\Delta V_j = V_{dc,j} - V_{s,j} = i_j \cdot R_{d,j} \quad (4)$$

The droop resistance value is used to limit the magnitude of the DC bus voltage deviation by following the equation:

$$R_{d,j} \leq \frac{\Delta V_{max}}{i_{fl,j}} \quad (5)$$

$V_{max}$  is the maximum allowable voltage deviation on the DC bus, and  $i_{fl,j}$  is the maximum load current according to the converter rating.

The load current sharing error between two DCGs is given by:

$$\Delta i_{1,2} = \frac{(R_{d2} + R_{line2}) \cdot (V_{dc1} - V_b) - (R_{d1} + R_{line1}) \cdot (V_{dc2} - V_b)}{(R_{d1} + R_{line1}) \cdot (R_{d2} + R_{line2})} \quad (6)$$

In order to obtain the small load power sharing error,  $\Delta i_{1,2}$  can be minimized by tuning the droop resistance, as written in Eq. (6).

The weakness of the traditional droop control can be proven by evaluating the effect of changing droop resistance and DC bus voltage regulation. A high droop resistance can be used to minimize the power sharing errors, but this technique will cause significant errors of the DC bus voltage deviation [28]. Fig.3 shows the influences of unequal cable line resistance on the load sharing. Fig.3 illustrates that if the droop resistance value is high, the load current sharing error will be small ( $\Delta i'_{1,2}$ ), and the dc bus voltage will be poor, and vice versa [29,30].

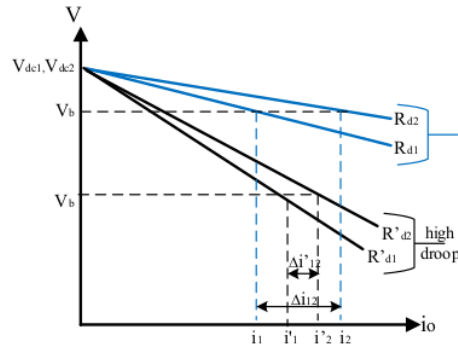

Fig. 3. Droop curve in a DCMG with cable line resistances are different and the nominal reference values are identical

### III. The Intelligent Adaptive Droop Control

The proposed droop control is needed to cover the weaknesses of the traditional droop control. Therefore, a control diagram for intelligent adaptive droop is presented, as shown in Fig. 4. In the primary control, the droop method is utilized to regulate each DC-DC converter to guarantee adequate current sharing between DCGs while the secondary control is responsible for eliminating the dc bus voltage deviation.

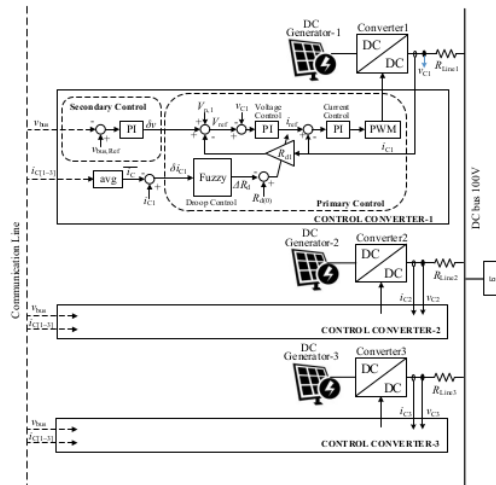

Fig. 4. The Control diagram of the intelligent adaptive droop control

The generator DC model can be represented by an adjustable current source that supplies power into the load [31]. The equivalent model of the proposed droop method with two sources is shown in Fig. 5. The two current sources are controlled by the converter with the same capacity.  $R_{d1}$  and  $R_{d2}$  are virtual resistances that can be tuned by the droop resistance regulator.

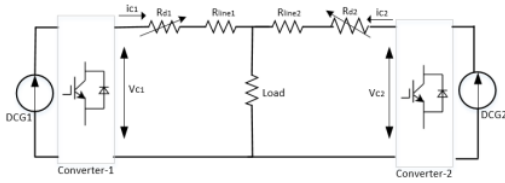

Fig. 5. Equivalent model of the Proposed Droop Method

Fig. 5 reveals the following relationship:

$$V_{c1} - (R_{d1} + R_{line1})i_{c1} = V_{c2} - (R_{d2} + R_{line2})i_{c2} \quad (7)$$

$$(R_{d1} + R_{line1})i_{c1} = (R_{d2} + R_{line2})i_{c2} \quad (8)$$

When both converters have the same external characteristic resistances, the relations below are obtained:

$$R_{d1} + R_{line1} = R_{d2} + R_{line2} \quad (9)$$

$$i_{c1} = i_{c2} \quad (10)$$

Hence, when the voltage control, the current control and the droop resistance regulator operate together, all the parallel converters tend to have the same external characteristic resistance, which reduce error in the load sharing. [32]

### III.1. The Primary Control

The primary control is made up of several components, including the voltage control, the current control, and the droop control. The reference current is regulated by the voltage control, while the output current is set by the current control so that it can determine the reference value. By using the droop control, the reference voltage increases linearly with decreasing converter output current. The reference voltage of the voltage control can be written as:

$$V_{ref,i} = V_{n,i} - R_{d,i}i_{c,i} \quad (11)$$

$V_{n,i}$  represents the voltage threshold,  $R_{d,i}$  and  $i_{c,i}$  are the droop resistance and the output current of the  $i$ th converter, which is  $i = 1, 2, 3$ .

The reference voltage obtained from equation (11) is compared with the output voltage of each converter  $V_{c,i}$  and the error compensation is carried out by the PI controller. Hence the duty cycle for the converter- $i$  can be regulated.

In order to minimize the load power sharing error between DCGs due to the  $R_{line}$  changes, droop resistance is adjusted through an intelligent controller based on fuzzy logic. The maximum droop resistance is restricted by two parameters as in Eq. (5) [24]. The tuned droop resistance will cause voltage deviation on the DC bus. Therefore the secondary control is considered. [22].

### III.2. The Secondary Control

In order to restore the dc bus voltage to the desired value when the droop control is enabled, a secondary control is required. The secondary control uses a PI (proportional-integral) basic controller in order to obtain the voltage deviation compensation by the following formula:

$$\delta v = K_p (V_{bus,ref} - V_{bus}) + K_i \int (V_{bus,ref} - V_{bus}) dt \quad (12)$$

The proportional gain and the integral gain are symbolized by the parameters  $K_p$  and  $K_i$ , respectively. In each of the secondary control systems, the voltage deviation compensation  $\delta v$  is utilized to shift the droop lines as illustrated in Fig. 6. The reference voltage updated of each local converter is expressed in :

$$V_{ref,i} = V_{n,i} - R_{d,i}i_{c,i} + \delta v \quad (13)$$

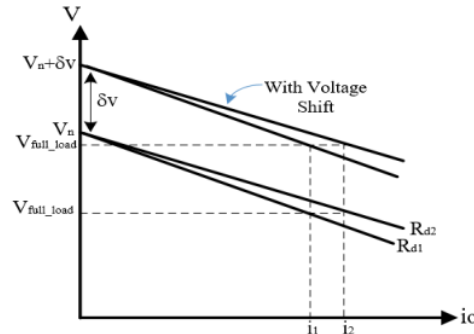

Fig. 6. The Droop curve with voltage shifting

### III.3. Fuzzy Tuning of The Droop Resistance

The main goal of developing fuzzy systems for tuning droop resistances is to ensure an accurate power sharing among DC sources in which line resistance is taken into account. The droop resistance value is affected by the difference in the output current of each converter.

This paper has proposed a Mamdani fuzzy logic controller (FLC) for tuning the droop resistance  $R_d$  at each converter system. The FLC uses the current difference of  $i$ th line ( $\delta i_c$ ) expressed in (14) as the inputs, and the resistance droop coefficient  $\Delta R_D$  as the output.

$$\begin{aligned} \delta i_{c,i} &= i_{c,i} - i_{c,avg} \\ &= i_{c,i} - \frac{\sum_{i=1}^n i_{c,i}}{n} \end{aligned} \quad (14)$$

$i_{c,avg}$  represents the average current of all the load conditions. Since the maximum load output value of the DC microgrid is set to 0.02kA, the value range of the  $\delta i_{c,i}$

is set within  $(-0.02, 0.02)$  kA. The range of the output  $(\Delta R_d)$  in the FLC can be set to be smaller than droop coefficient from equation (5), set  $R_d \in (-0.05, 0.05)$  [32-33].

Fig. 7 depicts the control surface of the proposed FLC, which summarizes the fuzzy logic controller's behavior. The droop resistance  $R_d$  at each unit can be tuned to reduce error of power sharing among of DC generators. The tuning of  $R_d$  is according to a fuzzy inference system that the output is a resistance droop coefficient  $(\Delta R_d)$ . Then, by relying on the current difference of  $i$ th line  $(\delta_{i,c,i})$ , the droop resistance will be increased or decreased.

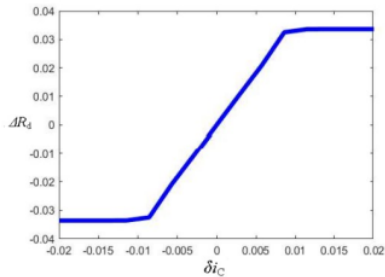

Fig. 7. Control Surfaces

#### IV. Simulation Results

The performance of the intelligent adaptive droop control is assessed using Matlab/Simulink software. From Fig. 4, there are three DCGs connected to 100V DC bus through a converter. Table 1 shows the converter parameters of the system.

TABLE I  
PARAMETER OF THE CONVERTER

Parameter	Symbol	Values
Input voltage	$V_{in}$	48V
Output voltage	$V_{out}$	100V
Converter inductance	$L$	3mH
Converter capacitance	$C$	1.1mF
Frequency Switching	$f_s$	50kHz

The performance testing on the DCMG system also compares the traditional droop control using a fixed droop resistance ( $R_{d0}=1\Omega$ ) with the intelligent adaptive droop control in the following scenarios.

##### IV.1. Scenario 1: Load Changes

In this scenario, the load variations from 1500W to 900W are evaluated at 1s. The load is suddenly changed at  $t=2$ s from 900W to 1200W. Each DCG has a different line resistance,  $R_{line1}=0,2\Omega$ ,  $R_{line2}=0,5\Omega$ , and  $R_{line3}=1\Omega$  respectively.

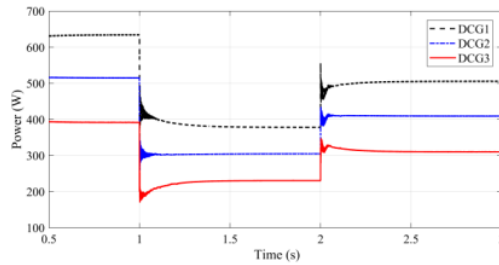

Fig. 8. The performance of load sharing using the fixed droop resistance under fluctuating loads

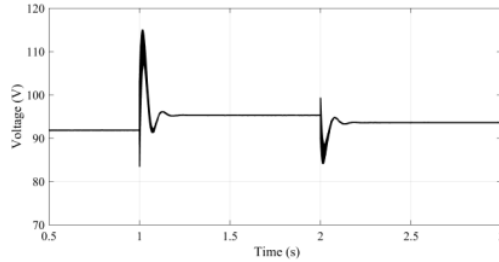

Fig. 9. The dc bus voltage performance using the fixed droop resistance under fluctuating loads

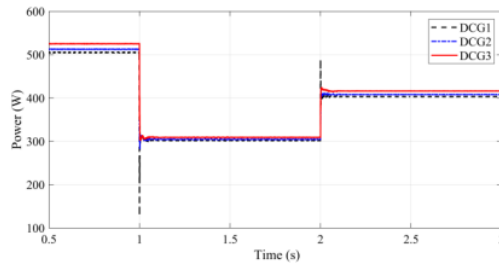

Fig. 10. The performance of load sharing using the intelligent adaptive droop control under fluctuating loads

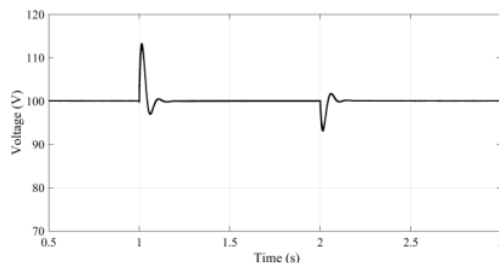

Fig. 11. The dc bus voltage performance using the intelligent adaptive droop control under fluctuating loads

Fig. 8 illustrates the power distribution under the traditional droop method. During the time 0s-1s, DCG1-DCG3 supplies power to the load of 625W, 515W, and 390W respectively. In fact, the load power sharing imbalance remains until the third second. It can be determined that the power ratio between DCGs is almost 1.2:1.0:0.8. Meanwhile, Fig. 9 shows that the maximum DC bus voltage deviation reaches -7% of the desired

voltage, 100V. A more proportional balance of the load power sharing is illustrated in Fig.10. At the first load condition of 1500W, the adaptive droop control ensures a proportional power sharing between the three DCGs where the power from the first, the second, and the third DCGs are 505W, 514W, 528W respectively. The DCGs could share the loads nearly with the desired ratio of 1:1:1, even during the second and the third load conditions. Moreover, a more stable DC bus voltage is obtained by the proposed droop control than the traditional droop control. The DC bus voltage tends to be stable at 100V as shown in Fig.11.

The complete results of load power sharing testing under fluctuating loads are summarized in table II.

TABLE II  
THE COMPARISON OF LOAD SHARING PERFORMANCE UNDER FLUCTUATING LOADS

Line resistance	Using the traditional droop		Using the intelligent droop		
	Output power (W)	Power ratio	Output power (W)	Power ratio	
0s-1s	DCG1 DCG2 DCG3	625 515 390	1.23 1.01 0.76	505 514 528	0.98 1.00 1.02
1s-2s	DCG1 DCG2 DCG3	389 307 218	1.27 1.01 0.72	301 303 306	0.99 0.99 1.01
2s-3s	DCG1 DCG2 DCG3	506 407 308	1.24 1.00 0.76	403 410 422	0.98 1.00 1.02

IV.2. Scenario 2

The line resistance effect is one of the well-known practical problems in the droop control technique. Therefore, the proposed droop method performance has been also tested by varying the line resistance in the DCMG system.

At the beginning, the line resistances are set to 0.2Ω, 0.5Ω and 1Ω, respectively, while the load power in this scenario remains at 1000W. At 1s-2s, the line resistances are increased gradually to 0.4Ω, 0.9Ω and 1.6Ω. Then, all the line resistances are slowly reduced to 0.3Ω, 0.7Ω and 1.3Ω. since 2s. Fig. 12 illustrates the load power sharing for each DCGs with the traditional droop control. At 0s-1s, the DCG1-DCG3 output powers are 379W, 312W, and 236W respectively. When the  $R_{line}$  varies at 1s-3s, the traditional droop control also cannot guarantee a balance of load power sharing between three DCGs, and the power sharing ratio reaches 1.23:1.01:0.76. The effect of using the traditional drop control makes the DC bus voltage fluctuate with a maximum voltage deviation of -5.9% as shown in Fig.13.

The high accuracy of load power sharing using the proposed droop control is shown in Fig. 14. At 1s-2s, the output powers of DCG1-DCG3 are 337W, 343W, and 351W respectively. With a fluctuating  $R_{line}$  value until the

third second, this method can achieve a power sharing ratio between three DCGs, which is 1:1:1. It is proved that the fuzzy logic can compensate for load power sharing errors by tuning the droop resistance even under the line resistance changes. The DC bus voltage in this case is still stable at 100. Although there is still a voltage deviation as shown in Fig. 15, it can be seen that the voltage deviation is very small at ±0.25%. Table III summarizes in detail the results of power sharing as illustrated in Fig. 12 and Fig. 14.

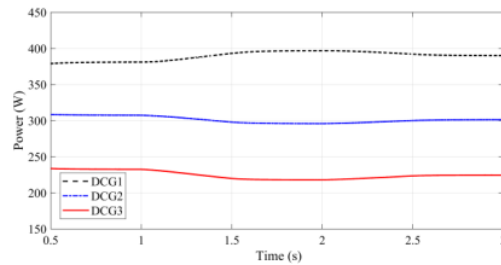

Fig. 12. The performance load sharing using the fixed droop resistance under line resistance changes

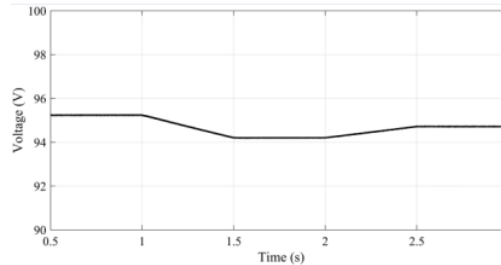

Fig. 13. The de bus voltage performance using fixed droop resistance under line resistance changes

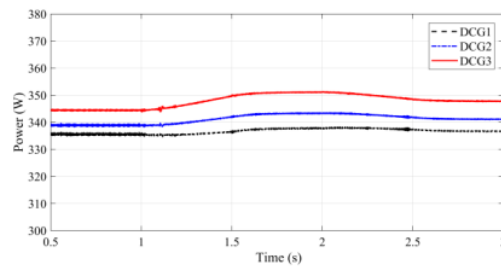

Fig. 14. The performance load sharing using the intelligent adaptive droop control under line resistance changes



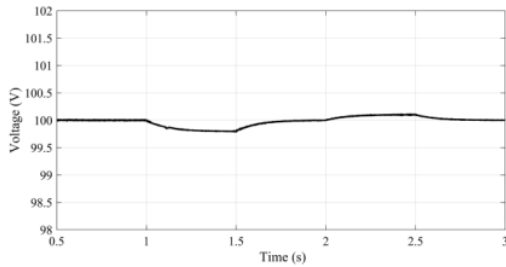

Fig. 15. The dc bus voltage performance using the intelligent adaptive droop control under line resistance changes

TABLE III  
THE COMPARISON OF LOAD SHARING PERFORMANCE  
UNDER LINE RESISTANCE CHANGES

Line resistance		Using the traditional droop		Using the intelligent droop	
		Output power (W)	Power ratio	Output power (W)	Power ratio
0s-1s	DCG1	379	1.23	335	0.99
	DCG2	312	1.01	338	0.98
	DCG3	236	0.76	344	1.01
1s-2s	DCG1	388	1.29	337	0.99
	DCG2	300	0.97	343	1.00
	DCG3	220	0.73	351	1.02
2s-3s	DCG1	385	1.27	336	0.99
	DCG2	300	0.99	341	1.00
	DCG3	225	0.74	347	1.02

### V. Conclusion

The adaptive droop control using fuzzy logic on DC microgrid has been presented. Fuzzy logic adjusts the droop resistance based on the average output current of all converters. The communication line is needed to obtain the average current of the converter. This research aims to reduce the load sharing error of each converter due to line resistance changes, so that the proportional load sharing between DC generators can be achieved. In order to prove the proposed adaptive droop control performance, fluctuations in load power and line resistance are considered. The simulation results show that a new droop control strategy based on fuzzy logic can balance the generation power ratio between DC generators, where the ratio is close to 1:1:1. In order to reduce the impact of using the adaptive droop control, the DC bus voltage is restored by the secondary control using a PI controller. The proposed strategy control has been verified through Matlab simulation. Further research can include fuzzy droop control on multiple batteries or in DC hybrid microgrid

### Acknowledgements

This paper is taken from a part of doctoral research and funded by the Education Fund Management Institute (LPDP) Indonesia

### References

- [1] F. S. Al-Ismael, "DC Microgrid Planning, Operation, and Control: A Comprehensive Review," *IEEE Access*, vol. 9, pp. 36154–36172, 2021.
- [2] E. Espina, J. Llanos, C. Burgos-Mellado, R. Cárdenas-Dobson, M. Martínez-Gómez, and D. Sáez, "Distributed control strategies for microgrids: An overview," *IEEE Access*, vol. 8, pp. 193412–193448, 2020.
- [3] S. Ansari, A. Chandel, and M. Tariq, "A Comprehensive Review on Power Converters Control and Control Strategies of AC/DC Microgrid," *IEEE Access*, vol. 9, pp. 17998–18015, 2021.
- [4] Mohamed M, Mostafa M, El-Satter A (2019) An Adaptive droop control scheme for DC microgrids integrating sliding mode voltage and current controlled Boost converters. *IEEE Trans Smart Grid* 1:1–9
- [5] M. Effendy, M. Ashari, and H. Suryoatmojo, "Performance Comparison of Proportional-Integral and Fuzzy-PI for a Droop Control of DC Microgrid," *Proceeding - 2020 Int. Conf. Sustain. Energy Eng. Appl. Sustain. Energy Transp. Towar. All-Renewable Futur. ICSEEA 2020*, pp. 180–184, 2020.
- [6] D. N. Huu, "An innovative adaptive droop control based on available energy for dc micro distribution grids," *Energies*, vol. 13, no. 11, 2020.
- [7] S. W. Lee and J. Kim, "Small-signal modeling, integration, and hardware implementation for optimized DC distribution system based on hierarchical control master-slave structure," *Electr. Power Syst. Res.*, vol. 177, no. August, p. 105998, 2019.
- [8] Z. Liu *et al.*, "Existence and Stability of Equilibrium of DC Micro-Grid under Master-Slave Control," *IEEE Trans. Power Syst.*, vol. 37, no. 1, pp. 212–223, 2022.
- [9] R. Zhang, A. V. Savkin, and B. Hredzak, "Centralized nonlinear switching control strategy for distributed energy storage systems communicating via a network with large time delays," *J. Energy Storage*, vol. 41, no. February, p. 102834, 2021.
- [10] M. Mehdi, C. H. Kim, and M. Saad, "Robust centralized control for DC islanded microgrid considering communication network delay," *IEEE Access*, vol. 8, pp. 77765–77778, 2020.
- [11] J. Kumar, A. Agarwal, and V. Agarwal, "A review on overall control of DC microgrids," *J. Energy Storage*, vol. 21, pp. 113–138, 2019.
- [12] Y. Han, X. Ning, P. Yang, and L. Xu, "Review of Power Sharing, Voltage Restoration and Stabilization Techniques in Hierarchical Controlled DC Microgrids," *IEEE Access*, vol. 7, pp. 149202–149223, 2019.
- [13] N. Ghanbari and S. Bhattacharya, "Adaptive Droop Control Method for Suppressing Circulating Currents in DC Microgrids," *IEEE Open Access J. Power Energy*, vol. 7, no. December 2019, pp. 100–110, 2020.
- [14] R. Kumar and M. K. Pathak, "Distributed droop control of dc microgrid for improved voltage regulation and current sharing," *IET Renew. Power Gener.*, vol. 14, no. 13, pp. 2499–2506, 2020.
- [15] J. Mohammadi and F. Badrkhani Ajaci, "Improved Mode-Adaptive Droop Control Strategy for the DC Microgrid," *IEEE Access*, vol. 7, pp. 86421–86435, 2019.
- [16] E. K. Belal, D. M. Yehia, and A. M. Azmy, "Adaptive droop control for balancing SOC of distributed batteries in DC microgrids," *IET Gener. Transm. Distrib.*, vol. 13, no. 20, pp. 4667–4676, 2019.
- [17] Y. Mi, H. Zhang, Y. Fu, C. Wang, P. C. Loh, and P. Wang, "Intelligent power sharing of dc isolated microgrid based on fuzzy sliding mode droop control," *IEEE Trans. Smart Grid*, vol. 10, no. 3, pp. 2396–2406, 2019.

- [18] J. Fang, Z. Shuai, X. Zhang, X. Shen, and Z. J. Shen, "Secondary Power Sharing Regulation Strategy for a DC Microgrid via Maximum Loading Factor," *IEEE Trans. Power Electron.*, vol. 34, no. 12, pp. 11856–11867, 2019.
- [19] W. W. A. G. Da Silva, T. R. Oliveira, and P. F. Donoso-Garcia, "Hybrid Distributed and Decentralized Secondary Control Strategy to Attain Accurate Power Sharing and Improved Voltage Restoration in DC Microgrids," *IEEE Trans. Power Electron.*, vol. 35, no. 6, pp. 6458–6469, 2020.
- [20] M. A. Mahmud, T. K. Roy, S. Saha, M. Enamul Haque, and H. R. Pota, "Robust Nonlinear Adaptive Feedback Linearizing Decentralized Controller Design for Islanded DC Microgrids," *IEEE Trans. Ind. Appl.*, vol. 55, no. 5, pp. 5343–5352, 2019.
- [21] M. Nasir, Z. Jin, H. A. Khan, N. A. Zaffar, J. C. Vasquez, and J. M. Guerrero, "A Decentralized Control Architecture Applied to DC Nanogrid Clusters for Rural Electrification in Developing Regions," *IEEE Trans. Power Electron.*, vol. 34, no. 2, pp. 1773–1785, 2019.
- [22] T. L. Nguyen, J. M. Guerrero, and G. Griepentrog, "A Self-Sustained and Flexible Control Strategy for Islanded DC Nanogrids without Communication Links," *IEEE J. Emerg. Sel. Top. Power Electron.*, vol. 8, no. 1, pp. 877–892, 2020.
- [23] Mohamed A. Ghalib, E. G. Shehat, Jean Thomas, R. M. Mostafa, "Adaptive droop control for high-performance operation in low-voltage DC microgrids," Springer-Verlag GmbH Germany, part of Springer Nature 2019
- [24] Y. Huang and C. K. Tse, "Circuit theoretic classification of parallel connected dc-dc converters," *IEEE Trans. Circuits Syst. I Regul. Pap.*, vol. 54, no. 5, pp. 1099–1108, 2007.
- [25] J. Mohammadi and F. Badrkhani Ajaei, "Improved Mode-Adaptive Droop Control Strategy for the DC Microgrid," *IEEE Access*, vol. 7, pp. 86421–86435, 2019.
- [26] Y. Jiang, Y. Yang, S. C. Tan, and S. Y. R. Hui, "Power Loss Mitigation of Parallel-Connected Distributed Energy Resources in DC Microgrids Using a Dual-Ascent Hierarchical Control," *2021 IEEE IAS Ind. Commer. Power Syst. Asia, I CPS Asia 2021*, vol. 36, no. 8, pp. 470–475, 2021.
- [27] Y. Zhang, X. Qu, M. Tang, R. Yao, and W. Chen, "Design of Nonlinear Droop Control in DC Microgrid for Desired Voltage Regulation and Current Sharing Accuracy," *IEEE J. Emerg. Sel. Top. Circuits Syst.*, vol. 11, no. 1, pp. 168–175, 2021.
- [28] Z. Yi, X. Zhao, D. Shi, J. Duan, Y. Xiang, and Z. Wang, "Accurate Power Sharing and Synthetic Inertia Control for DC Building Microgrids with Guaranteed Performance," *IEEE Access*, vol. 7, pp. 63698–63708, 2019.
- [29] K. D. Hoang and H. H. Lee, "Accurate power sharing with balanced battery state of charge in distributed DC microgrid," *IEEE Trans. Ind. Electron.*, vol. 66, no. 3, pp. 1883–1893, 2019.
- [30] W. W. A. G. Silva, T. R. Oliveira, and P. F. Donoso-Garcia, "An Improved Voltage-Shifting Strategy to Attain Concomitant Accurate Power Sharing and Voltage Restoration in Droop-Controlled DC Microgrids," *IEEE Trans. Power Electron.*, vol. 36, no. 2, pp. 2396–2406, 2021.
- [31] L. Kong and H. Nian, "Transient Modeling Method for Faulty DC Microgrid Considering Control Effect of DC/AC and DC/DC Converters," *IEEE Access*, vol. 8, pp. 150759–150772, 2020.
- [32] L. Zhang, K. Chen, S. Chi, L. Lyu, and G. Cai, "The hierarchical control algorithm for DC microgrid based on the improved droop control of fuzzy logic," *Energies*, vol. 14, no. 15, 2019.
- [33] J. Fadil, S. Soedibyo, and M. Ashari, "Novel of vertical axis wind turbine with variable swept area using fuzzy logic controller," *Int. J. Intell. Eng. Syst.*, vol. 13, no. 3, pp. 256–267, 2020.

### Authors' information

<sup>1</sup> Department of Electrical Engineering, Institut Teknologi Sepuluh Nopember, Surabaya 60111, Indonesia

<sup>2</sup> Departement of Electrical Engineering, University of Muhammadiyah Malang, 65144, Indonesia

\*Corresponding author's email : [ashari@ee.its.ac.id](mailto:ashari@ee.its.ac.id)



**Machmud Effendy** was born in Malang, Indonesia. He received B.S degree in electrical engineering from the University of Muhammadiyah Malang, Indonesia, and M.Eng degree in renewable energy system engineering from Gadjahmada University, Indonesia. He is currently a PhD candidate at the Electrical Department of Engineering, Institut Teknologi Sepuluh Nopember Surabaya (ITS), Indonesia.

His current resesarch interests include power converter and DC microgrids.



**Mochamad Ashari** was born in Sidoarjo, Indonesia. He received the B.S degree in electrical engineering from Institut Teknologi Sepuluh Nopember Surabaya, Indonesia. in 1989, and the M.S and Ph.D degrees in electrical engineering from Curtin University Australia in 1997 and 2002.

He is currently a full professor with the Department of Electrical Engineering, Institut Teknologi Sepuluh Nopember Surabaya, Indonesia,

His current research interest include oriented to renewable energy system, converter and distributed power system. He actively conducts research in collaboration with university in Japan and Australia as well as domestic institutions, and has produced more than 100 scientific papers published at the international level.

Prof. Mochamad Ashari was rector at Telkom University, Indonesia (2013-2018), now as rector at Institut Teknologi Sepuluh Nopember Surabaya, Indonesia (2019-2024).



**Heri Suryoatmojo** received his BS degree in Electrical Engineering from Institut Teknologi Sepuluh Nopember Surabaya, Indonesia.

in 2004, MS degree in Electrical Engineering from Institut Teknologi Sepuluh Nopember Surabaya, Indonesia in 2006, and Doctor of Engineering from Kumamoto University, Japan in 2010.

His current research interest include renewable energy system, converter, distributed power system, power electronics, electric machines and power systems.

Dr. Heri Suryoatmojo is currently a lecturer and researcher in Institut Teknologi Sepuluh Nopember Surabaya, Indonesia.

# Load Sharing and Voltage Restoration Improvement in DC Microgrids with Adaptive Droop Control Strategy

---

## ORIGINALITY REPORT

---

2%

SIMILARITY INDEX

2%

INTERNET SOURCES

2%

PUBLICATIONS

2%

STUDENT PAPERS

---

## MATCH ALL SOURCES (ONLY SELECTED SOURCE PRINTED)

---

2%

★ Indra Ranu Kusuma, Semin Semin, Muhammad Badrus Zaman, Sardono Sarwito, Kamarul Hawari Ghazali. "Comparison of Radial and Zonal DC Distribution System for Hybrid-Powered Trimaran Vessels Power Flow Analysis", International Review of Electrical Engineering (IREE), 2022

Publication

---

Exclude quotes  Off

Exclude bibliography  On

Exclude matches  < 2%