



Digital Receipt

This receipt acknowledges that Turnitin received your paper. Below you will find the receipt information regarding your submission.

The first page of your submissions is displayed below.

Submission author: Turnitin Instructor
Assignment title: Admin Similarity
Submission title: Characteristics of Butane Combustion in Mesoscale-Combustor...
File name: Mesoscale_Combustor_Due_to_Stainless_Steel_Flame_Holder...
File size: 1.53M
Page count: 13
Word count: 5,001
Character count: 24,900
Submission date: 30-Dec-2023 10:34AM (UTC+0700)
Submission ID: 2199751185

Journal of Advanced Research in Fluid Mechanics and Thermal Sciences 104, Issue 2 (2023) 161-173



Journal of Advanced Research in Fluid
Mechanics and Thermal Sciences

Journal homepage:
https://jurnal@utem.edu.my/journals/index.php/fluid_mechanics_thermal_sciences/index
ISSN: 2289-7879



Characteristics of Butane Combustion in Mesoscale-Combustor Due to Stainless Steel Flame Holder Type

Achmad Fauzan Hery Soegiharto¹, Fudhail Abdul Munir^{2*}, Iis Siti Aisyah³, Mahatma Putra Aryanamurti¹, Liliti Yuliaty¹, Evita Leninda Fahriza Ayuni¹

¹ Department of Mechanical Engineering, Faculty of Engineering, University of Muhammadiyah Malang, Indonesia
² Faculty of Mechanical Engineering, Universiti Teknikal Malaysia Melaka (UTeM), Hang Tuah Jaya, Durian Tunggal, Melaka
³ Department of Mechanical Engineering, Brawijaya University, Malang, Indonesia

ARTICLE INFO	ABSTRACT
<p>Article history: Received 25 November 2022 Received in revised form 18 March 2023 Accepted 16 March 2023 Available online 1 April 2023</p> <p>Keywords: Mesoscale combustor; micro power generator; butane combustion; flame holder</p>	<p>Mesoscale-combustor is one component of the micropower generator. The mesoscale-combustor function is to produce heat energy from the combustion of chemical hydrocarbon compounds. The small dimensions of the meso-combustor cause large losses and short residence times for the reactants. These two factors lead to narrow flame flammability limits. This study aims to increase flammability limits by lengthening the reactant residence time and increasing reactant mixing with inserts of flow retardants called flame holders. There are two kinds of flame holders used in this study, namely holes and fins. Lites type produces flames at an equivalent ratio of 0.83-1.76 and speeds of 17.03 cm/s to 72.93 cm/s, while holes type produces flames at an equivalent ratio of 0.95-1.71 and a flow rate of 24.94 cm/s to 54.95 cm/s. This phenomenon shows that the lites type flame holder is able to inhibit flow better and form vortices better, thereby increasing heat recirculation, flame stability, and widening flammability limits.</p>

1. Introduction

The development of the use of electronic devices has an impact on increasing battery usage [1]. However, batteries have major weaknesses, namely toxic waste and low energy density as shown in Table 1 [2,3]. To anticipate the weaknesses of batteries, micropower generator technology has been developed to generate electricity using hydrocarbon fuels [4]. One of the main components of a micropower generator is the small combustion chamber or combustor. Combustion chambers with tube dimensions below 1 mm are called micro-combustors, while combustion chambers of 1 mm to 1 cm are called meso-combustors [5,6].

The small size of the mesoscale combustor results in a short reactant residence time, large heat loss, and cooling of the combustion reaction by the walls [7]. This causes a narrow flammability limit; in other words, it is difficult to stabilize the flame in a mesoscale combustor.

^{*} Corresponding author.
E-mail address: fudhail@utem.edu.my
<https://doi.org/10.37934/arfmts.104.2.161173>

161

Characteristics of Butane Combustion in Mesoscale-Combustor Due to Stainless Steel Flame Holder Type

by Turnitin Instructor

Submission date: 30-Dec-2023 10:34AM (UTC+0700)

Submission ID: 2199751185

File name: Mesoscale_Combustor_Due_to_Stainless_Steel_Flame_Holder_Type.pdf (1.53M)

Word count: 5001

Character count: 24900

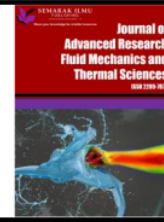

Characteristics of Butane Combustion in Mesoscale–Combustor Due to Stainless Steel Flame Holder Type

Achmad Fauzan Hery Soegiharto¹, Fudhail Abdul Munir^{2,*}, Iis Siti Aisyah¹, Mahatma Putra Aryanamurti¹, Lilis Yulianti³, Evita Leninda Fahriza Ayuni¹

¹ Department of Mechanical Engineering, Faculty of Engineering, University of Muhammadiyah Malang, Indonesia

² Faculty of Mechanical Engineering, Universiti Teknikal Malaysia Melaka (UTeM), Hang Tuah Jaya, Durian Tunggal, Malaysia

³ Department of Mechanical Engineering, Brawijaya University, Malang, Indonesia

ARTICLE INFO

ABSTRACT

Article history:

Received 25 November 2022

Received in revised form 8 March 2023

Accepted 16 March 2023

Available online 1 April 2023

Keywords:

Mesoscale combustor; micro power generator; butane combustion; flame holder

Mesoscale–combustor is one component of the micropower generator. The mesoscale–combustor function is to produce heat energy from the combustion of chemical hydrocarbon compounds. The small dimensions of the meso-combustor cause large losses and short residence times for the reactants. These two factors lead to narrow flame flammability limits. This study aims to increase flammability limits by lengthening the reactant residence time and increasing reactant mixing with inserts of flow retardants called flame holders. There are two kinds of flame holders used in this study, namely holes and lines. Lines type produces flames at an equivalent ratio of $\Phi 0.83$ – 1.76 and speeds of 17.01 cm/s to 72.93 cm/s, while holes type produces flames at an equivalent ratio of $\Phi 0.91$ – 1.71 and a flow rate of 24.94 cm/s to 54.95 cm/s. This phenomenon shows that the line type flame holder is able to inhibit flow better and form vortices better, thereby increasing heat recirculation, flame stability, and widening flammability limits.

1. Introduction

The development of the use of electronic devices has an impact on increasing battery usage [1]. However, batteries have major weaknesses, namely toxic waste and low energy density as shown in Table 1 [2,3]. To anticipate the weaknesses of batteries, micropower generator technology has been developed to generate electricity using hydrocarbon fuels [4]. One of the main components of a micropower generator is the small combustion chamber or combustor. Combustion chambers with tube dimensions below 1 mm are called micro-combustors, while combustion chambers of 1 mm to 1 cm are called meso-combustors [5,6].

The small size of the mesoscale combustor results in a short reactant residence time, large heat loss, and cooling of the combustion reaction by the walls [7]. This causes a narrow flammability limit; in other words, it is difficult to stabilize the flame in a mesoscale combustor.

* Corresponding author.

E-mail address: fudhail@utem.edu.my

<https://doi.org/10.37934/arfmts.104.2.161173>

Table 1
Energy density of various sources [2]

Source	Energy density [MJ/kg]
Lead acid batteries	0.0792
Nickel cadmium (NiCad) batteries	0.158
Lithium ion batteries	0.468
Lithium sulfur batteries	0.792
Methanol combustion	22,7
Ethanol combustion	30.5
Heating oil combustion	42.5
Diesel combustion	45,3
Gasoline combustion	45,8
n-Octane combustion	48,2
n-Butane combustion	49,6
Propane combustion	50,3
Methane combustion	55.5
Hydrogen combustion	142

The role of the mesh as a flame holder is to prevent flashback and blowoff. The preferred procedure for determining the most accurate mesh is to perform trials on different mesh sizes and configurations until a numerical solution converges, called a grid independence test. Obviously, this requires a lot of computational time and effort. Turbulent flow is significantly affected by the presence of walls, where the viscosity affected region has a large gradient in solution variables and the accurate presentation of the region near the wall determines the predictive success of wall bounded turbulent flow [8].

The hexane propane flame was successfully stabilized in a tube type mesoscale combustor with an inner diameter of 3.5 mm, with double mesh inserts. The results show that wire mesh inserts are able to expand the flammability limit when compared to single wire mesh [9]. Double mesh inserts play a role in (a) inhibiting the flow thereby prolonging the residence time of the reactants, (b) increasing the recirculation of heat from the flame to the reactants [10]. The role of the wire mesh is then referred to as the flame holder, where the flame sticks or slightly sticks to the wire mesh. This also occurs in the use of liquid fuels [1]. Further investigation also explains that the flame holder material also has an effect on increasing the flammability limit [11]. Copper, which has a high conductivity, does extend the flammability limit, but is easily deformed at high temperatures, so it is not recommended for use as a flame holder. Based on this research, flame holders and flame holder materials are proven to increase heat recirculation and expand the flammability limit. In order to create stable combustion in micro combustor, many experimental studies have been carried out and natural gas is applied for most conditions. Heat recirculation and external heating are common and effective methods for reducing heat loss. Recirculation heat which means the enthalpy of the burned gas is recirculated to heat the reactants [12].

Previous research has been carried out by Gan *et al.*, [12] which used the electrospray technique for burning liquid fuels. The liquid fuel is dispersed into droplets so that the evaporation rate increases rapidly. Unlike gas fuel, fine evaporation is a prerequisite for burning liquid fuels [12]. The electrospray atomization method creates droplets with an electric charge, which causes the spread of the spray due to the repulsive force between the droplets.

Using other methods, this paper describes the use of various types of flame holders and their impact on flammability limits, flame visualization and combustion temperatures in butane combustion in a mesoscale combustor.

2. Methodology

The research was conducted using the experimental method, namely direct observation of the object to be studied. The data obtained from the research will be processed, analyzed, and compared with the results of the hypothesis. The research was conducted in the Mechanical Engineering Laboratory of the University of Muhammadiyah Malang.

Figure 1 is a mesoscale combustor figure that will be used in this study. Figure 1(a) shows the technical drawing of the mesoscale combustor with the flow rate from the inlet to the outlet. Figure 1(b) is a combustor with a wire mesh flame holder as a reference for the flammability limit from a previous study by Mikami *et al.*, [9] and Yuliati [11]. Figure 1(c) is a mesoscale combustor with perforated plate flame holder holes and Figure 1(d) is a mesoscale combustor with lines of perforated plate as a treatment in the study. Between the two, visualization and flame temperature observations will be carried out, in order to get an in-depth understanding of the effects of variations in the use of flame holders.

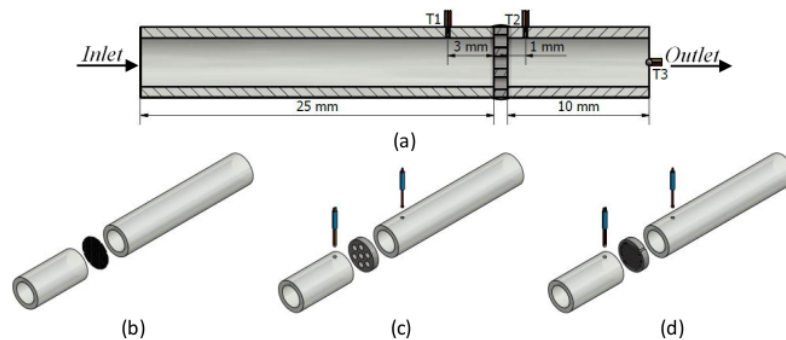

Fig. 1. Meso-combustor (a) Technical drawing of mesoscale combustor (b) Wire mesh meso scale combustor (c) Holes perforated plate meso scale combustor (d) Lines perforated plate meso scale combustor

Figure 2 shows a series of equipment used for research. The fuel in the mesoscale-combustor is butane and the fuel discharge will be regulated by the fuel flowmeter. Air from the compressor as oxidizing gas is supplied to the combustor and the air flow is regulated using a Kofloc RK-1250 air flowmeter. The mixture of fuel and oxidizing gas will be combined with a Y – connector, and forwarded to the combustion chamber. The use of a burner to raise the temperature around the combustor so that combustion can occur. The thermocouple is used to retrieve temperature data that occurs when combustion is in progress. The camera is a tool for taking visualization data on the flame in the combustor.

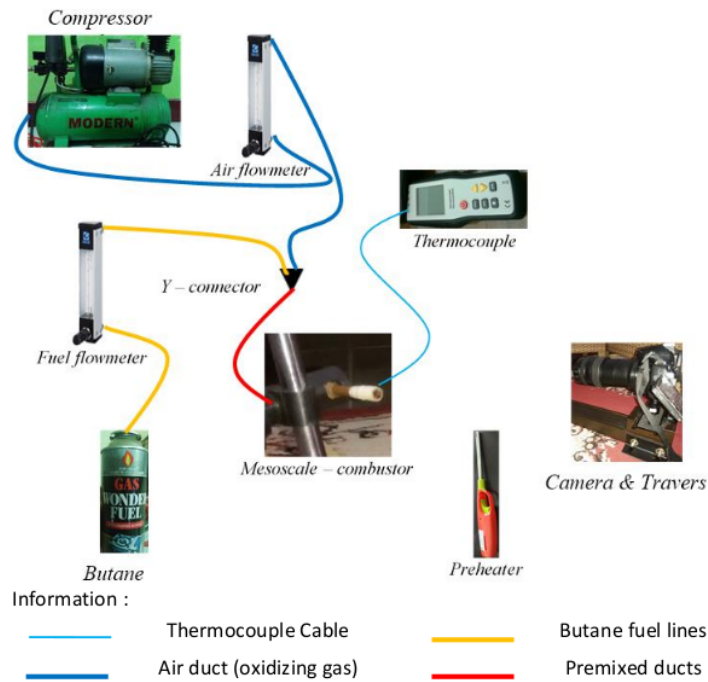

Fig. 2. Research installation scheme

3. Results

3.1 Flammability Limits

The area between the minimum curve and the maximum curve is the stabilized flame area in the combustor. The higher the equivalent ratio means that the reactant mixture is more fuel-rich mixture, whereas if the equivalent ratio is lower, a fuel-lean mixture will occur, as shown in Figure 3. The flow velocity through the combustion chamber is slightly inhibited and capable of raising the temperature before the reactants enter the flame region.

Meso combustor with perforated plate holes, the flow of reactant through the hole is the smoothest, so the flow resistance is less when compared to mesh 60. Lines perforated plate flame holder is the type that inhibits the flow the most and has the largest contact area.

Mesoscale combustor with 3 different types has different flame stability and reactant flow rate. In the perforated plate holes, a stable flame occurs in the equivalent ratio range $\Phi 0.91-1.71$ and the reactant flow rate ranges from 24.94–54.95 cm/s, then the flame perforated plate lines are stabilized in the equivalent ratio range $\Phi 0.83-1.76$ with a maximum speed in the range of 17.01–72.93 cm/s, while for the mesoscale combustor with 60 mesh the flame holder can be stabilized at an equivalent ratio of $\Phi 0.90$ to 1.53. The area of the 60 mesh curve appears wider than the area of the mesoscale combustor perforated plate holes.

A steady flame is characterized by a flame that sticks or barely sticks to the flameholder. On a stable flame, no blowoff or flashback occurs. In a stable flame state, the flame holder plays a role in the occurrence of heat recirculation. The heat generated by the flame will heat the flame holder, the flame holder heats the reactant passing through it, then the reactant temperature will rise, and the reactant will enter the flame area at a higher temperature. The right amount of heat and the right heat flow rate will cause flame stability.

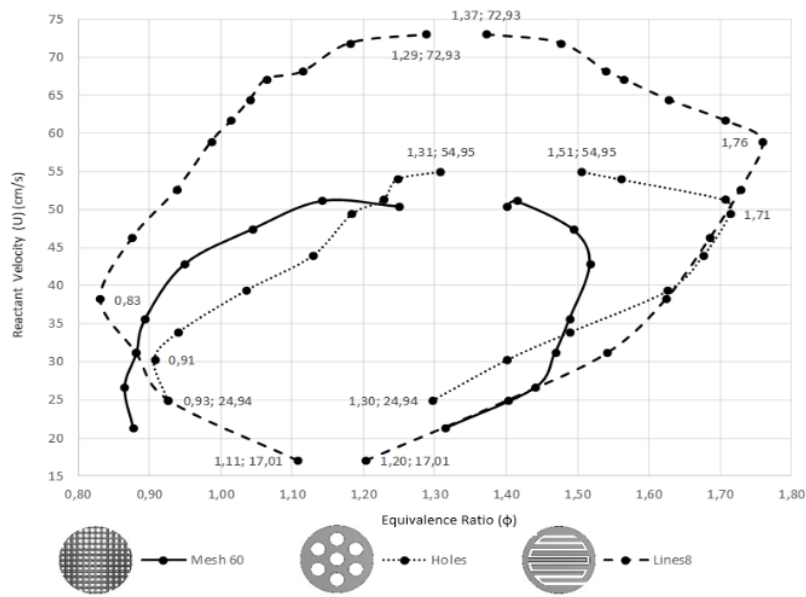

Fig. 3. Flammability limit

The flame holder causes resistance to the flow of the reactant, while increasing the residence time of the reactant longer. Increasing the residence time of the reactant provides an opportunity for heat absorption, so that the temperature of the reactant can be higher. The contact surface area of the flame holder and reactant is also the convection heat transfer surface area. The convection surface area and residence time of the reactant increase the absorption of heat into the reactant. However, recirculation of heat downstream that is too fast can cause flame heat to be absorbed even faster than the heat produced from combustion. This causes the flame to cool which results in the flame being easily extinguished, so that the flammability limits become narrower.

The flame is kept within the flammability limit so that the resulting combustion is optimal by adjusting the equivalent ratio and flow rate of the reactants that occur in the mesoscale-combustor. In the next sub-chapter, we will explain the visualization of the flame on the combustor.

3.2 Visualization of the Flame

Image capture of the flame visualization was carried out by knowing the midpoint of the flammability limit of the 3 types of flame holders, using wire mesh as a reference for comparison that has been carried out by Mikami *et al.*, [9] and Yuliati [11], the other two were the treatments in this study, namely perforated plate holes and perforated plate lines as depicted in Figure 4. The center point is also useful as the main reference and determines 2 additional points on the left and right sides for visualization which will form a horizontal line and also 2 points on the top and bottom sides to produce a visualization of the vertical line. The five dots that will form horizontally and vertically only represent a comparison of the visualization of the flame with the flammability limit.

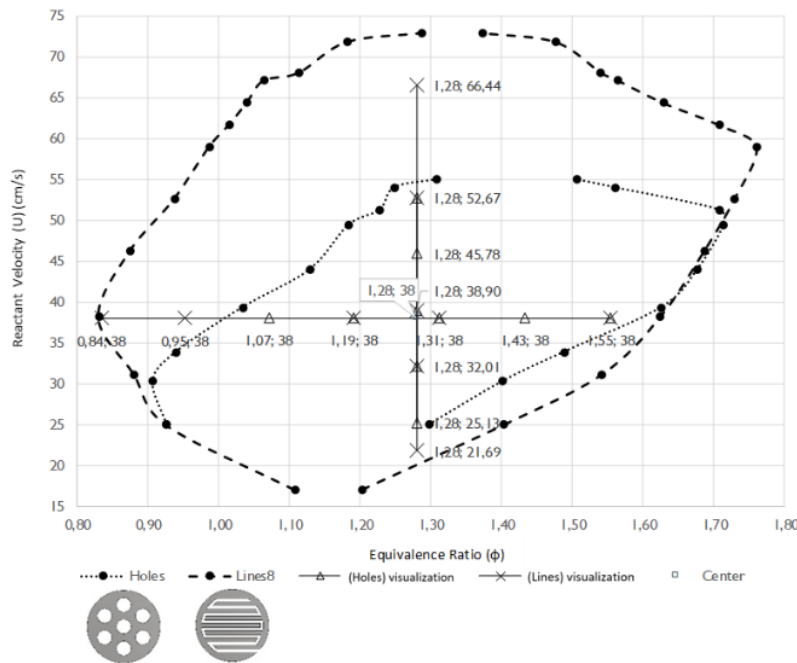

Fig. 4. Flammability limit for visualization take point and flame temperature

At a low reactant velocity, $U = 25.13 \text{ cm/s}$, the mass of the reactant flowing is small, so the heat of combustion is also low, and the flame that occurs is small, as shown in Figure 5. There is an area without a flame on the edge of the wall which occurs due to the presence of the reactant, not burnt. Along with increasing reactant velocity, the total mass and heat of combustion products increase. When the flame becomes larger, the gap without flame narrows. This flameless gap occurs because the heat of combustion is small and unable to overcome the cooling by the wall. This cooling by the walls causes the reactants near the walls to not have enough energy to start combustion. The unburned gas area at T_2 will be narrower because the increase in speed U can increase the temperature (251.3°C to 308.4°C) and the flame will enlarge. The addition of reactant velocity causes blow-off. The temperature of the flame region drops T_2 (289.3°C) then the combustion reactions start to occur and the temperature downstream of T_3 increases, as shown in Figure 6.

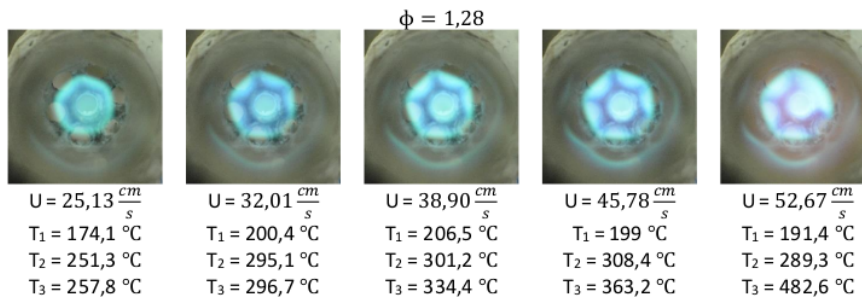
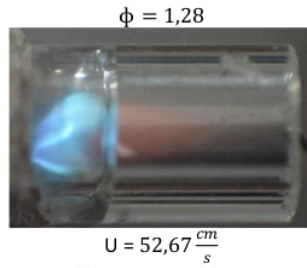

Fig. 5. Mesoscale flame visualization – combustor holes perforated plate on $\phi = 1,28$ and U varies (front side)



$U = 52,67 \frac{cm}{s}$
 $T_1 = 191,4 \text{ }^\circ\text{C}; T_2 = 289,3 \text{ }^\circ\text{C}; T_3 = 482,6 \text{ }^\circ\text{C}$

Fig. 6. Visualization of perforated plate flame holes at $\phi = 1,28$ and $U = 52.67 \text{ cm/s}$ (side side)

The flame on the fame mesoscale-combustor with lines flame holder gives a greater flame when compared to the flame on the mesoscale combustor with holes perforates plate, as shown in Figure 7 and Figure 8 at $\phi = 1.28$ and $U 21.69 \text{ cm/s}$ the flame is visible the smallest. The flame increased in size and remained stable with the addition of U to 52.67 cm/s and temperature $T_2 = 381^\circ\text{C}$.

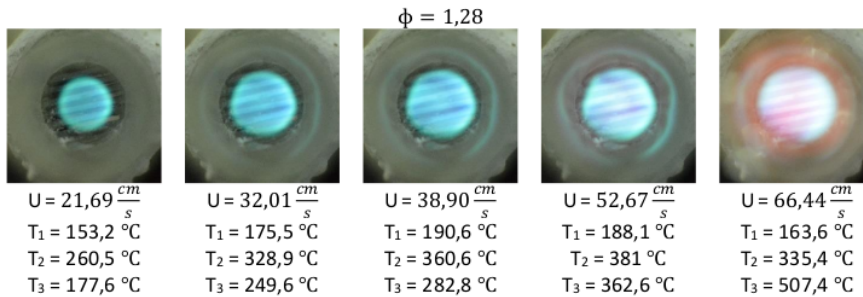

Fig. 7. Mesoscale flame visualization – combustor lines perforated plate on ϕ constant (front side)

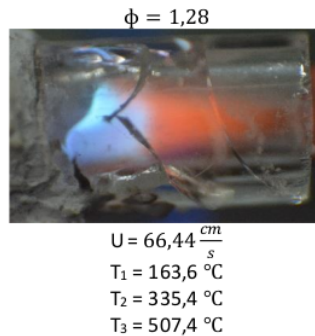

Fig. 8. Mesoscale flame visualization – combustor lines perforated plate on ϕ constant (side-side)

The flame is able to remain stable up to $U = 66.44$ cm/s which is close to the maximum speed limit on the flammability limit. At the reactant velocity, the exhaust gas temperature reaches T_3 (507.4), the flame remains stable attached to the flame holder extending until it exits the mesoscale combustor. At this reactant velocity, a blow-off begins to occur which is marked by a decrease in the temperature of T_2 to 335.4°C, then a crack occurs (Figure 8).

Observation of the mesoscale flame with a hole perforated plate type flame holder, at a constant reactant velocity, as shown in Figure 9, shows that the richer the fuel, the more difficult it is to ignite. It was shown from the visualization of the flame, that in lean mixture the temperature was high, the flame almost filled the cross section, and the gap without flame was thin, whereas in rich mixture the gap without flame was getting thicker. Butane concentration has a physical effect on the heating and combustion processes. Butane has twice the density of air, Specific Heat-Cp 1675 J/kgK, Thermal Conductivity 0.017 W/m°C, while air has a Density (at 0°C and 1 bar) 1.276 kg/m³, thermal conductivity at 0°C and 1 bar 24.35 mW/(mK), Specific heat capacity (Cp) of water at 0°C and 1 bar 4.1818 kJ/kgK. This can be interpreted that the more butane, the more heat is needed to raise the temperature. The heat from the flame will be absorbed a lot which will eventually cool the flame. The perforated plate type flame holder produces a smoother flow of reactant, so the residence time is shorter.

Figure 9 describes that flame visualization occurs at a constant flow velocity U at 38 cm/s. The flame at low ϕ (1.07) looks thin, dark blue, getting lighter and thicker at high ϕ (1.55). The more reactants that flow, the more fuel is contained in it, until there is insufficient air condition to carry out the combustion reaction. The temperature of $T_2 = 330.5^\circ\text{C}$ at $\phi = 1.07$ will decrease at $\phi = 1.55$ to produce $T_2 = 229.7^\circ\text{C}$. This causes the fuel to absorb flame heat and heat loss occurs due to not being able to produce heat for combustion. In this condition, the flame area near the wall experiences greater heat absorption due to cooling by the wall, so that a cold area will form a flameless gap. Cold areas are increasingly dominant with an increase in ϕ , because the fuel will cool the walls causing heat loss and it will go out.

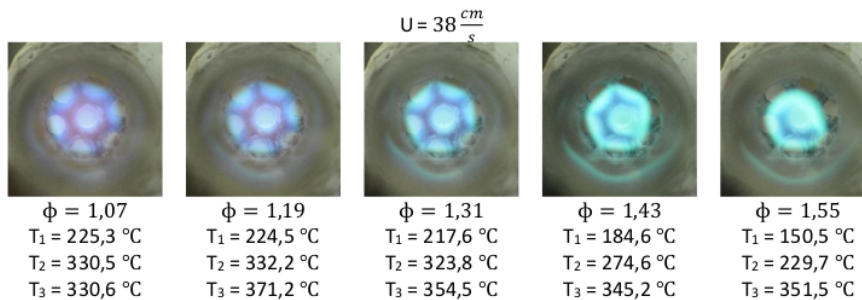

Fig. 9. Mesoscale flame visualization – combustor holes perforated plate on u constant (front side)

Mesoscale-combustor with lines perforated plate flame holder, produces different flame characteristics as shown in Figure 10. At reactant velocity $U = 38$ cm/s, and $\Phi = 0.84$, the flame looks thin, dark blue, then gets thicker and brighter at high Φ ($\Phi = 1.55$).

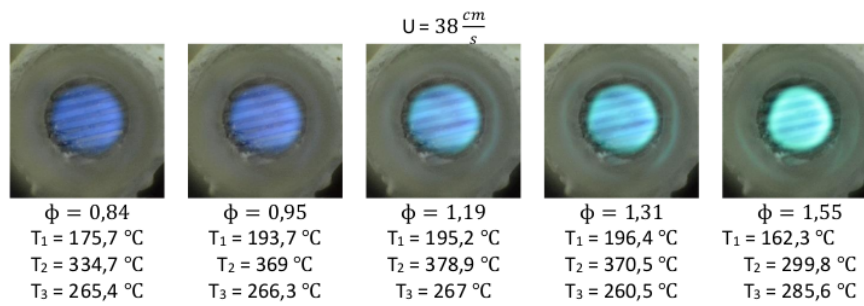

Fig. 10. Mesoscale flame visualization – combustor lines perforated plate on $U = \text{constant}$ (front side)

The richer the mixture $\Phi = 0.84$, $\Phi = 0.95$, $\Phi = 1.19$, the brighter the flame, the larger the diameter of the flame, and the higher the flame temperature, namely from $T_2 = 334.7^\circ\text{C}$, $T_2 = 369^\circ\text{C}$, $T_2 = 378,9^\circ\text{C}$. This shows that the better combustion produces more heat. However, after $\Phi = 1.19$, the richer the mixture, the flame diameter decreases. The line perforated plate type flame holder provides better flow resistance than the perforated plate type. This resistance causes the circulation of fluid flow and at the same time improves the heat transfer. However, when the reactant mixture is even richer, there is a lack of oxygen, so that some of the fuel does not burn which causes the flame to shrink. Flame reduction is compounded by cooling by walls and cooling by unburned fuel or reactants.

The increase in heat transfer in the channel can be caused by many factors, the material of the wall, the type of fluid flowing in it, the thermal properties of the fluid, etc. An increase in heat transfer generally means an increase in the heat transfer rate, from Newton's law of cooling, and the overall heat transfer equation can be observed that by increasing the convection heat transfer coefficient, thermal conductivity, surface area and the difference between surface and fluid temperature the heat transfer rate can be increased. Enhancement technique means a method or means by which the value of the thermal conductivity (k) or the convection heat transfer coefficient (h) can be increased. There are many methods of increasing heat transfer, the principle of these methods is to reduce the thickness of the thermal boundary layer, increase the interruption in the fluid and increase the velocity gradient near the wall [13].

From the various descriptions above, it shows that by using a variation of the flame holder lines it is able to maximize combustion. At constant ϕ , increasing U will create better heat recirculation than flame holder holes. The shape of the flame with the addition of U will become wider. Whereas at a constant U , ϕ increases, it will cause the temperature of T_2 to decrease and T_3 to increase. When compared to holes, the use of perforated plate lines is more optimal in combustion because the resulting T_2 temperature is higher and the T_3 temperature is lower.

3.3 Flow Simulation

CFD simulation is used as software that allows to investigate more complex fluid dynamics in two or three dimensions consisting of 3 stages, namely: pre-processing, processing and post-processing. Creating geometry and meshing becomes the pre-processing stage, the mesh parameter was set-up with CFD physics and fluent solver preference, then proceeds to the parameter setup, iteration or boundary condition setting stage, to the post processing stage which includes analysis, visualization, and data validation simulation results [14,15]. In this study using ANSYS R17.0 software to analyze various types of structures, fluid flow, and heat transfer.

Figure 11 shows that there is less turbulence in the combustor inlet area, because the flow experiences a sudden reduction which is affected by the smaller area of the flame holder at the front. Turbulent flow has heat due to contact with the flame holder and the heat that has been formed will be able to be cooled by the reactants that have not burned in the inlet area.

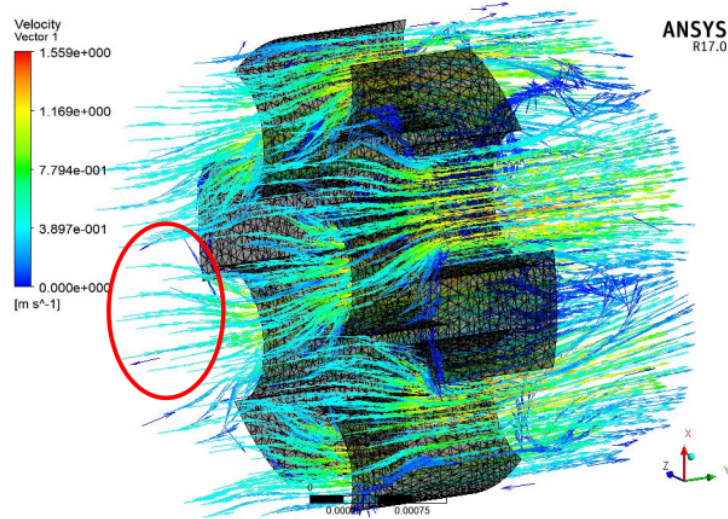

Fig. 11. Isometric view of the inlet combustor flame holder holes

Using flame holder lines (Figure 12) increases the potential for flow turbulence due to the increased sudden reduction which is directly proportional to the area of contact on the front side of the flame holder, as a result the heat in the inlet area increases and is more stable. Turbulent flow in the preheating area (before the reactants burn) is beneficial because it gives the reactants a chance to stay longer in the combustor, so that the resulting heat recirculation is more even.

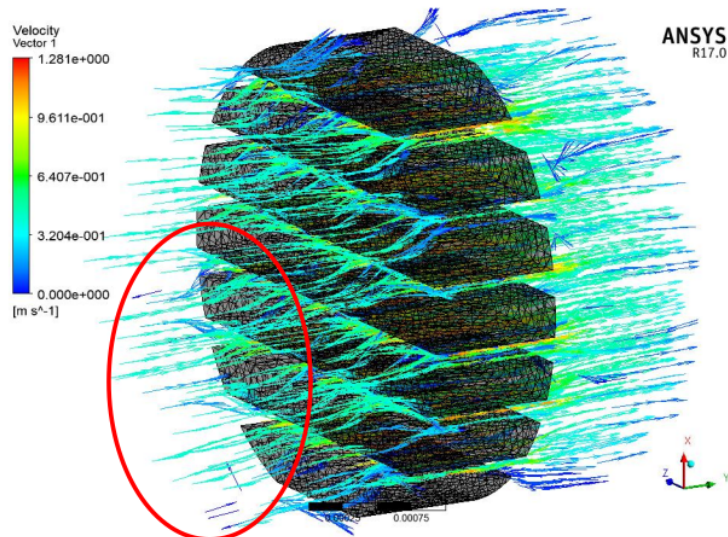

Fig. 12. Isometric view of the inlet combustor flame holder lines

The results of the flow simulation from the side can be seen in Figure 13 (flame holder holes). Turbulence occurs due to a sudden enlargement that is greater in the outlet area which causes reactants with higher heat (high temperature) to be cooled by reactants with lower heat (low temperature), whereas reactants with low heat (low temperature) will receive heat from reactants with greater heat (high temperature). This causes the combustion heat to be concentrated in turbulent flow and the heat in the right area of the flame will decrease.

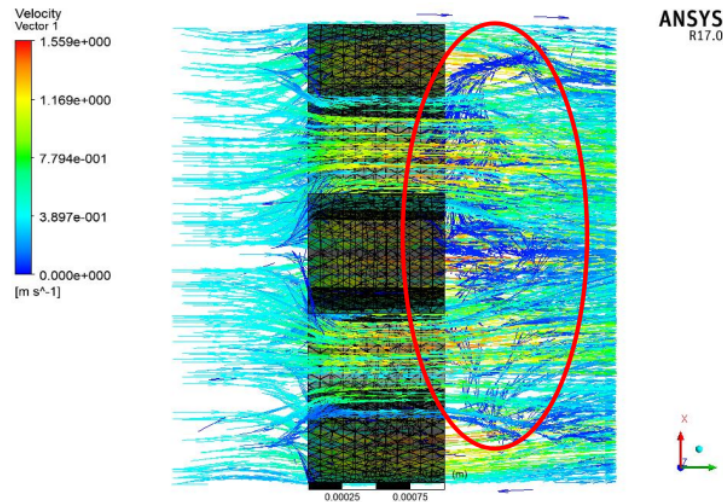

Fig. 13. Side view of the combustor flame holder holes

In Figure 14, it can be seen that by increasing the contact area of the line type flame holder can suppress turbulence due to the small sudden enlargement that will occur in the flow in the outlet area. This can cause heat at high temperatures to increase heat at low temperatures, besides that the combustion heat in the combustor will be spread evenly throughout, maximum heat recirculation will occur to increase combustion heat, and the flame can be more stabilized.

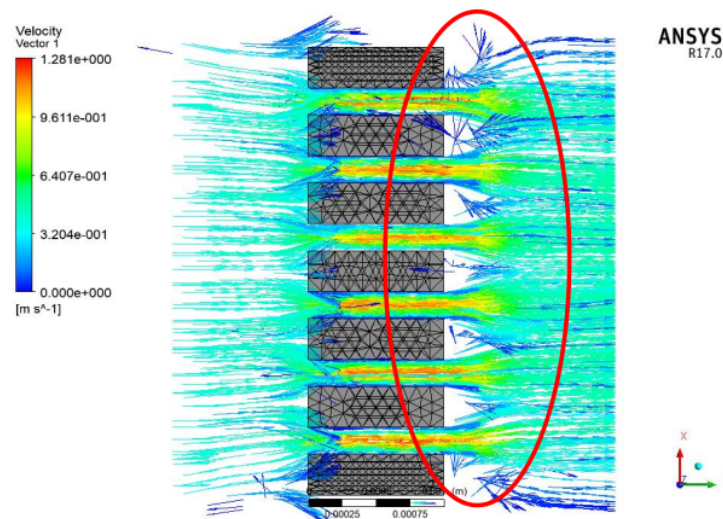

Fig. 14. Side view of the combustor flame holder lines

4. Conclusions

4.1 Conclusion

The conclusions from the research on the combustion characteristics of mesoscale-butane gas fueled combustors with variations of the flame holder are as follows

- i. The flame in the combustor is more stable by using flame holder lines perforated plates because the flow turbulence in the outlet area is reduced.
- ii. The use of flame holder lines can increase the flow velocity U up to 72.93 cm/s.
- iii. Flame holder lines have a larger contact area than flame holder holes, so they can increase heat recirculation and extend the residence time of fuel in the combustion chamber.
- iv. Visualization of the shape of the flame will increase in size with increasing flow velocity U , then thicker, light blue, and smaller with an increase in the equivalent ratio ϕ .

4.2 Suggestions

- i. It is necessary to use a better glass tube material because cracks will disturb the visualization of the flame on the mesoscale in the combustor.
- ii. In future research, you can add a thermocouple problem to the reactants that will burn (enter the center diameter of the combustor) and the exact point of the flame (center diameter of the combustor), so that a more thorough heat transfer analysis can be carried out.

Acknowledgement

This research was funded by a grant from University of Muhammadiyah Malang, Indonesia.

References

- [1] Aravind, B., Bhupendra Khandelwal, P. A. Ramakrishna, and Sudarshan Kumar. "Towards the development of a high power density, high efficiency, micro power generator." *Applied Energy* 261 (2020): 114386. <https://doi.org/10.1016/j.apenergy.2019.114386>
- [2] Kaisare, Niket S., and Dionisios G. Vlachos. "A review on microcombustion: Fundamentals, devices and applications." *Progress in Energy and Combustion Science* 38, no. 3 (2012): 321-359. <https://doi.org/10.1016/j.pecs.2012.01.001>
- [3] Aravind, B., Bhupendra Khandelwal, and Sudarshan Kumar. "Experimental investigations on a new high intensity dual microcombustor based thermoelectric micropower generator." *Applied Energy* 228 (2018): 1173-1181. <https://doi.org/10.1016/j.apenergy.2018.07.022>
- [4] Fernandez-Pello, A. Carlos. "Micropower generation using combustion: Issues and approaches." *Proceedings of the Combustion Institute* 29, no. 1 (2002): 883-899. [https://doi.org/10.1016/S1540-7489\(02\)80113-4](https://doi.org/10.1016/S1540-7489(02)80113-4)
- [5] Maruta, Kaoru. "Micro and mesoscale combustion." *Proceedings of the Combustion Institute* 33, no. 1 (2011): 125-150. <https://doi.org/10.1016/j.proci.2010.09.005>
- [6] Dunn-Rankin, Derek, Elisângela Martins Leal, and David C. Walther. "Personal power systems." *Progress in Energy and Combustion Science* 31, no. 5-6 (2005): 422-465. <https://doi.org/10.1016/j.pecs.2005.04.001>
- [7] Chou, S. K., W. M. Yang, K. J. Chua, J. Li, and K. L. Zhang. "Development of micro power generators-a review." *Applied Energy* 88, no. 1 (2011): 1-16. <https://doi.org/10.1016/j.apenergy.2010.07.010>
- [8] Azman, Azraf, Mohd Zamri Yusoff, Azfarizal Mukhtar, Prem Gunnasegaran, Nasri A. Hamid, and Ng Khai Ching. "Numerical study of heat transfer enhancement for mono and hybrid nanofluids flow in a straight pipe." *CFD Letters* 13, no. 2 (2021): 49-61. <https://doi.org/10.37934/cfdl.13.2.4961>
- [9] Mikami, Masato, Yoshiyuki Maeda, Keiichiro Matsui, Takehiko Seo, and Lilis Yuliati. "Combustion of gaseous and liquid fuels in meso-scale tubes with wire mesh." *Proceedings of the Combustion Institute* 34, no. 2 (2013): 3387-3394. <https://doi.org/10.1016/j.proci.2012.05.064>
- [10] Yuliati, Lilis, Mega Nur Sasongko, and Slamet Wahyudi. "Flammability limit and flame visualization of gaseous fuel

- combustion inside meso-scale combustor with different thermal conductivity." In *Applied Mechanics and Materials*, vol. 493, pp. 204-209. Trans Tech Publications Ltd, 2014. <https://doi.org/10.4028/www.scientific.net/AMM.493.204>
- [11] Yuliati, Lilis. "Flame Stability of Gaseous Fuel Combustion Inside Meso-Scale Combustor with Double Wire Mesh." In *Applied Mechanics and Materials*, vol. 664, pp. 231-235. Trans Tech Publications Ltd, 2014. <https://doi.org/10.4028/www.scientific.net/AMM.664.231>
- [12] Gan, Yunhua, Xiaowen Chen, Yang Tong, Xia Zhang, and Yang Zhang. "Thermal performance of a meso-scale combustor with electrospray technique using liquid ethanol as fuel." *Applied Thermal Engineering* 128 (2018): 274-281. <https://doi.org/10.1016/j.applthermaleng.2017.09.016>
- [13] Khdher, Abdolbaqi Mohammed, Nor Azwadi Che Sidik, Siti Nurul Akmal Yusof, and M'hamed Beriache. "Heat Transfer Enhancement in Straight Channel with Nanofluid In Fully Developed Turbulent Flow." *Journal of Advanced Research in Applied Mechanics* 63, no. 1 (2019): 1-15.
- [14] Qing, Nelvin Kaw Chee, Nor Afzanizam Samiran, and Razlin Abd Rashid. "CFD Simulation analysis of Sub-Component in Municipal Solid Waste Gasification using Plasma Downdraft Technique." *CFD Letters* 14, no. 8 (2022): 63-70. <https://doi.org/10.37934/cfdl.14.8.6370>
- [15] Syofi'i, Imam, Dendy Adanta, Aji Putro Prakoso, and Dewi Puspita Sari. "Application of Computational Fluid Dynamics Method for Cross-flow Turbine in Pico Scale." *JEMMME (Journal of Energy, Mechanical, Material, and Manufacturing Engineering)* 6, no. 1 (2021): 1-8. <https://doi.org/10.22219/jemmmme.v6i1.12813>

Characteristics of Butane Combustion in Mesoscale-Combustor Due to Stainless Steel Flame Holder Type

ORIGINALITY REPORT

13%

SIMILARITY INDEX

9%

INTERNET SOURCES

7%

PUBLICATIONS

4%

STUDENT PAPERS

MATCH ALL SOURCES (ONLY SELECTED SOURCE PRINTED)

2%

★ ijritcc.org

Internet Source

Exclude quotes Off

Exclude matches Off

Exclude bibliography On