

GAMBAR KERJA & DESAIN PERENCANAAN PEMBANGUNAN PERUMAHAN ASSHOFA



OLEH:

AZMI WAHYU IKHSAN (202110340311133)

RO'YATUL MAULANA S. (202110340311108)

MOH FATIH ABDURRAHMAN (202110340311175)

AVICENNA HARITZMI A. R. (202110340311212)

**JURUSAN TEKNIK SIPIL
FAKULTAS TEKNIK
UNIVERSITAS MUHAMMADIYAH MALANG
2025**

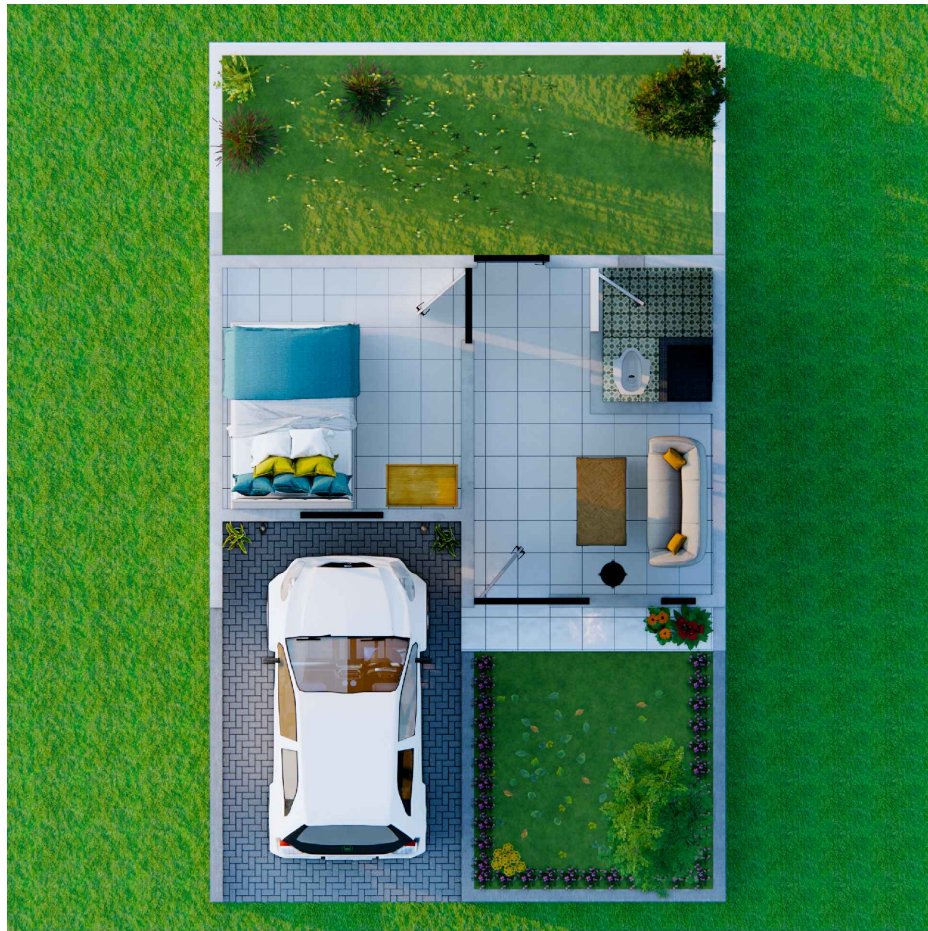

JURUSAN SIPIL
FAKULTAS TEKNIK



UNIVERSITAS
MUHAMMADIYAH
MALANG

DOSEN PEMBIMBING

IR. YUNAN RUSDIANTO., MT
AULIA INDIRA KUMALASARI, ST., MT

NAMA MAHASISWA

AZMI WAHYU IKHSAN
(202110340311133)

RO'YATUL MAULANA S.
(202110340311108)

MOH FATIH ABDURRAHMAN
(202110340311175)

AVICENNA HARITZMI A. R.
(202110340311212)

NAMA GAMBAR

DESAIN RENDER

SKALA GAMBAR

KETERANGAN

NO. GAMBAR

KERTAS

A3

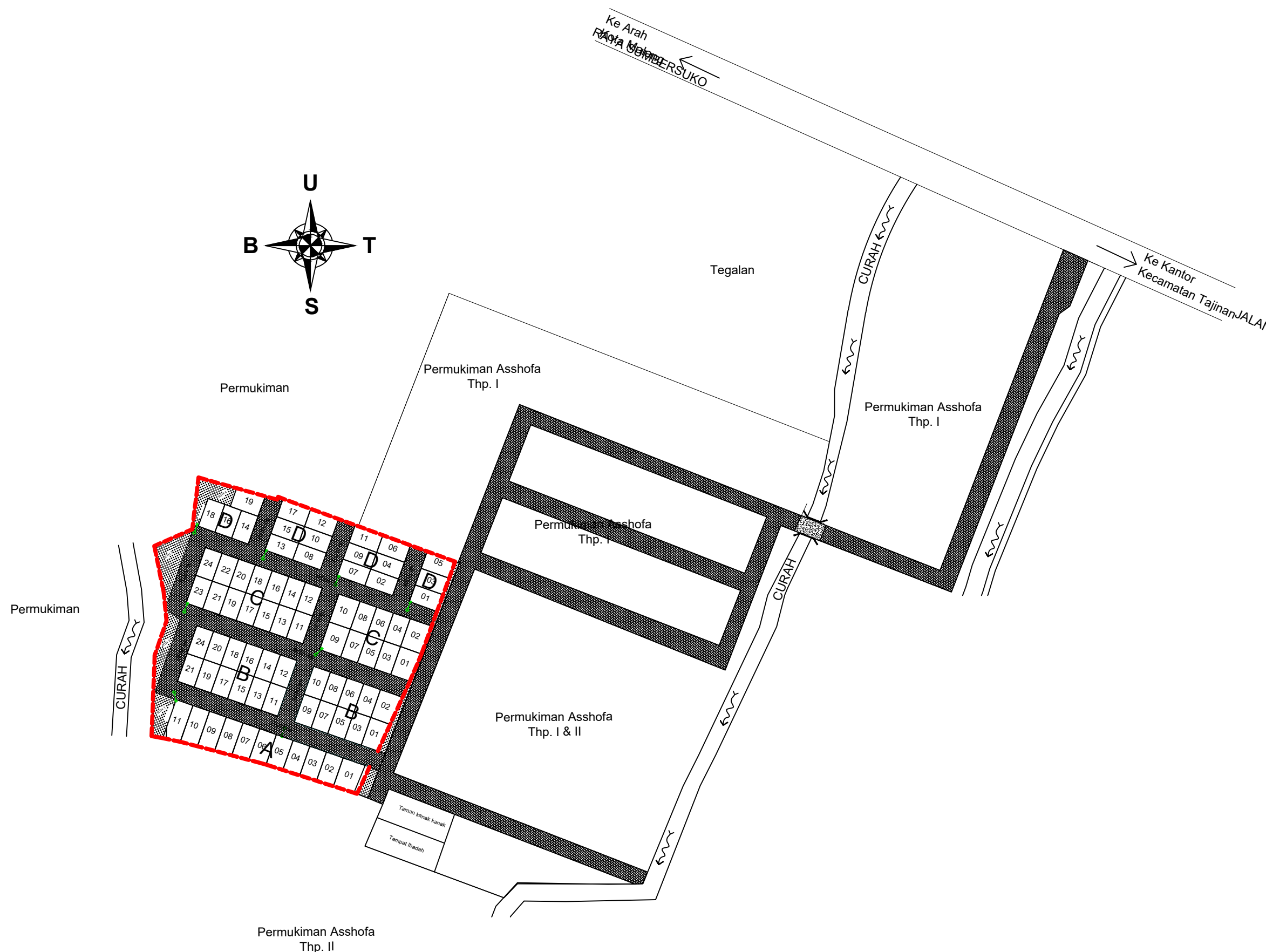

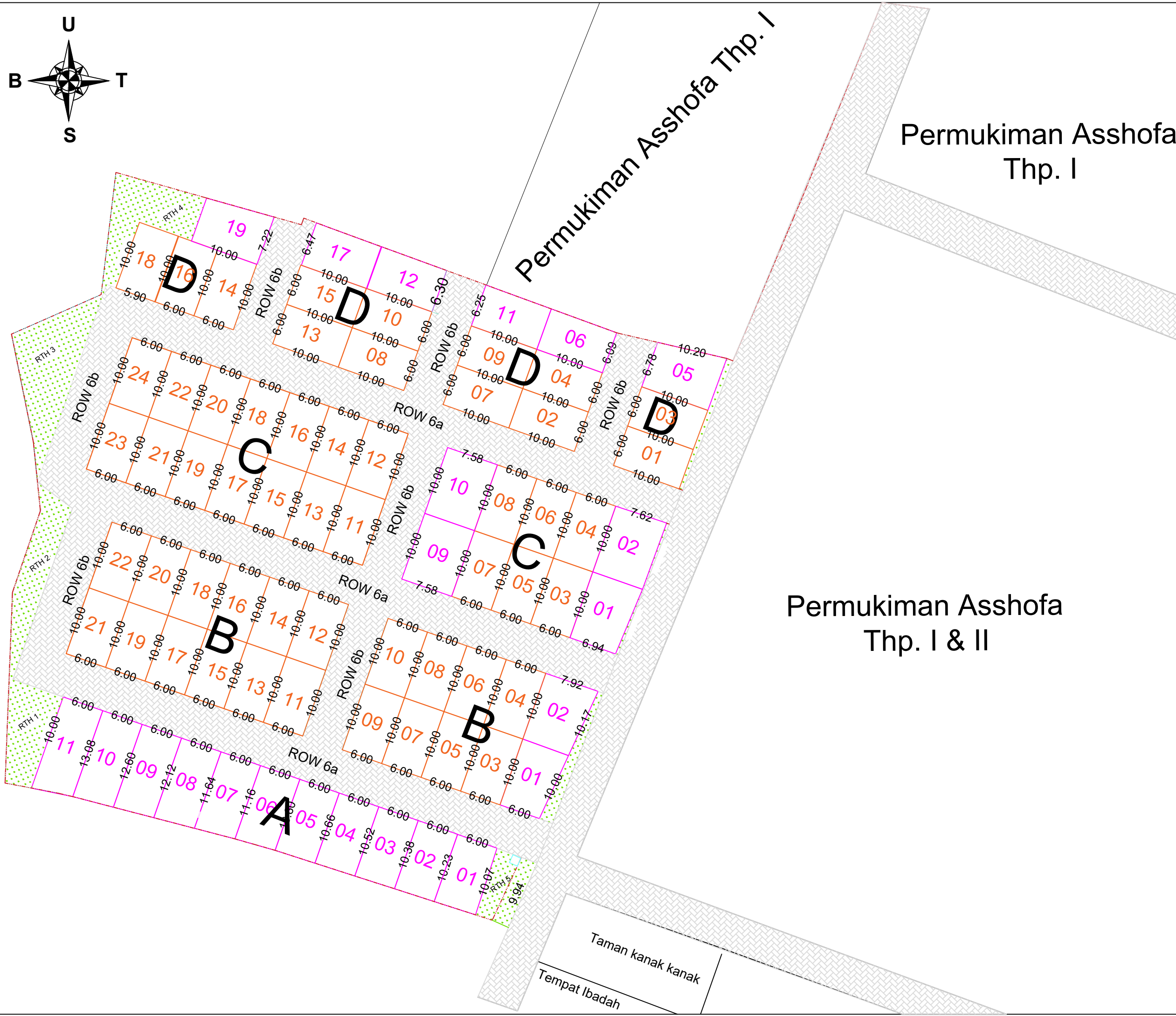
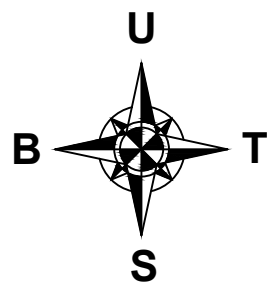

DOSEN PEMBIMBING

IR. YUNAN RUSDIANTO., MT
AULIA INDIRA KUMALASARI, ST., MT

NAMA MAHASISWA

AZMI WAHYU IKHSAN
(202110340311133)
RO'YATUL MAULANA S.
(202110340311108)
MOH FATIH ABDURRAHMAN
(202110340311175)
AVICENA HARITZMI A. R.
(202110340311212)

NAMA GAMBAR

SITEPLANE

SKALA GAMBAR

KETERANGAN

NO. GAMBAR

KERTAS

A3



DOSEN PEMBIMBING

IR. YUNAN RUSDIANTO., MT
AULIA INDIRA KUMALASARI, ST., MT

NAMA MAHASISWA

AZMI WAHYU IKHSAN
(202110340311133)

RO'YATUL MAULANA S.
(202110340311108)

MOH FATIH ABDURRAHMAN
(202110340311175)

AVICENA HARITZMI A. R.
(202110340311212)

NAMA GAMBAR

RENCANA
FASUM KAWASAN

SKALA GAMBAR

KETERANGAN

NO. GAMBAR

KERTAS

A3

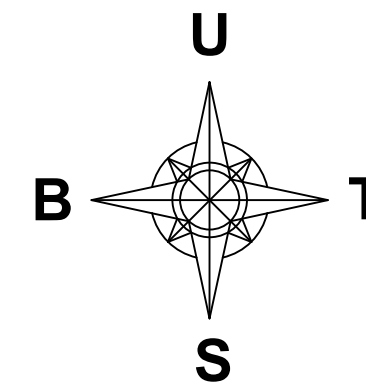
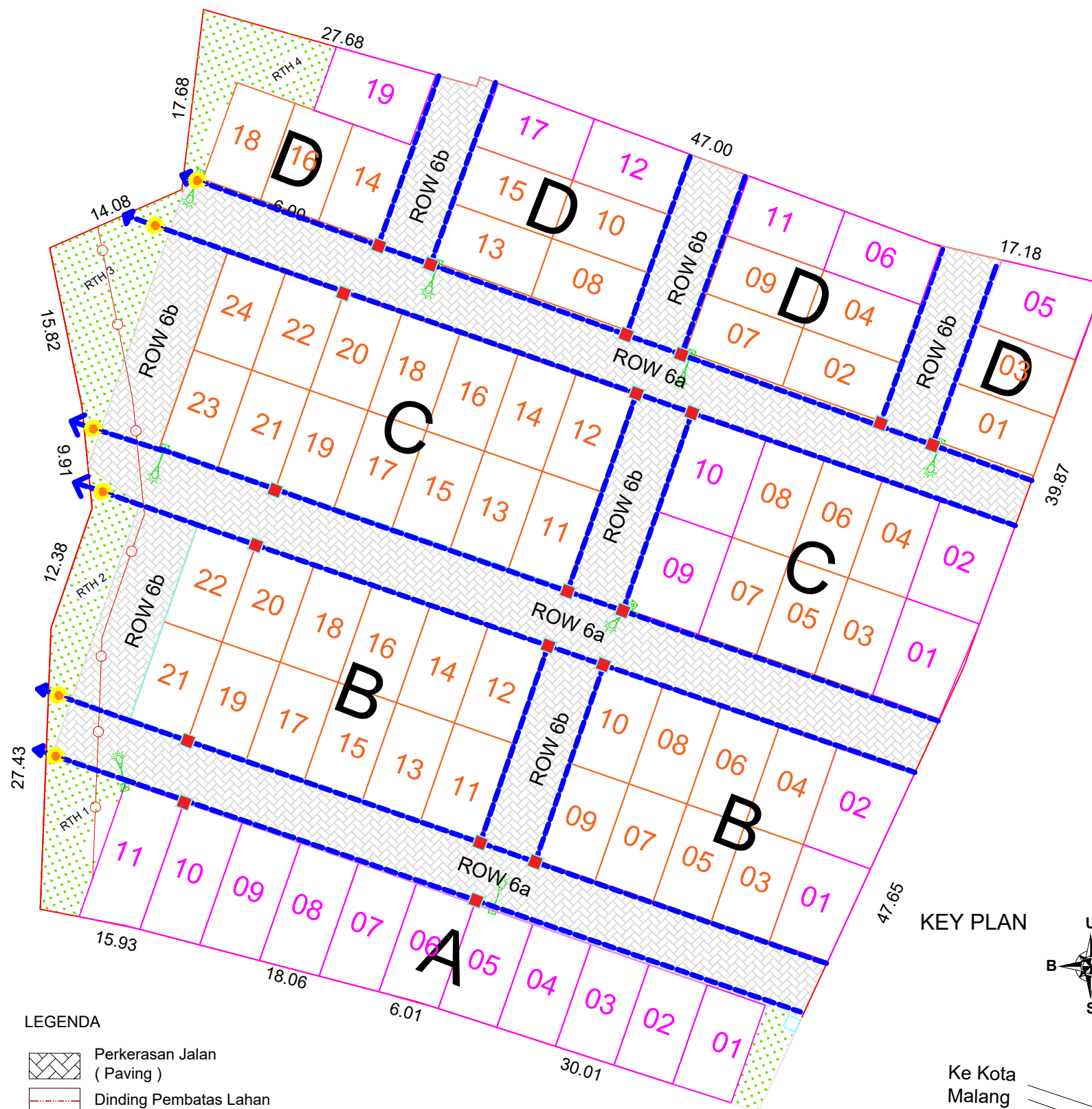

KEY PLAN

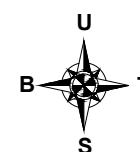

LEGENDA

- Perkerasan Jalan (Paving)
- Dinding Pembatas Lahan
- Taman / RTH
- Penerangan Jalan Umum (PJU)
- Sumur Resapan
- Garis Sempadan Sungai (GSS)
- Arah Aliran Drainase
- Pos Satpam
- BAK KONTROL

Keterangan

- Lokasi Perumahan



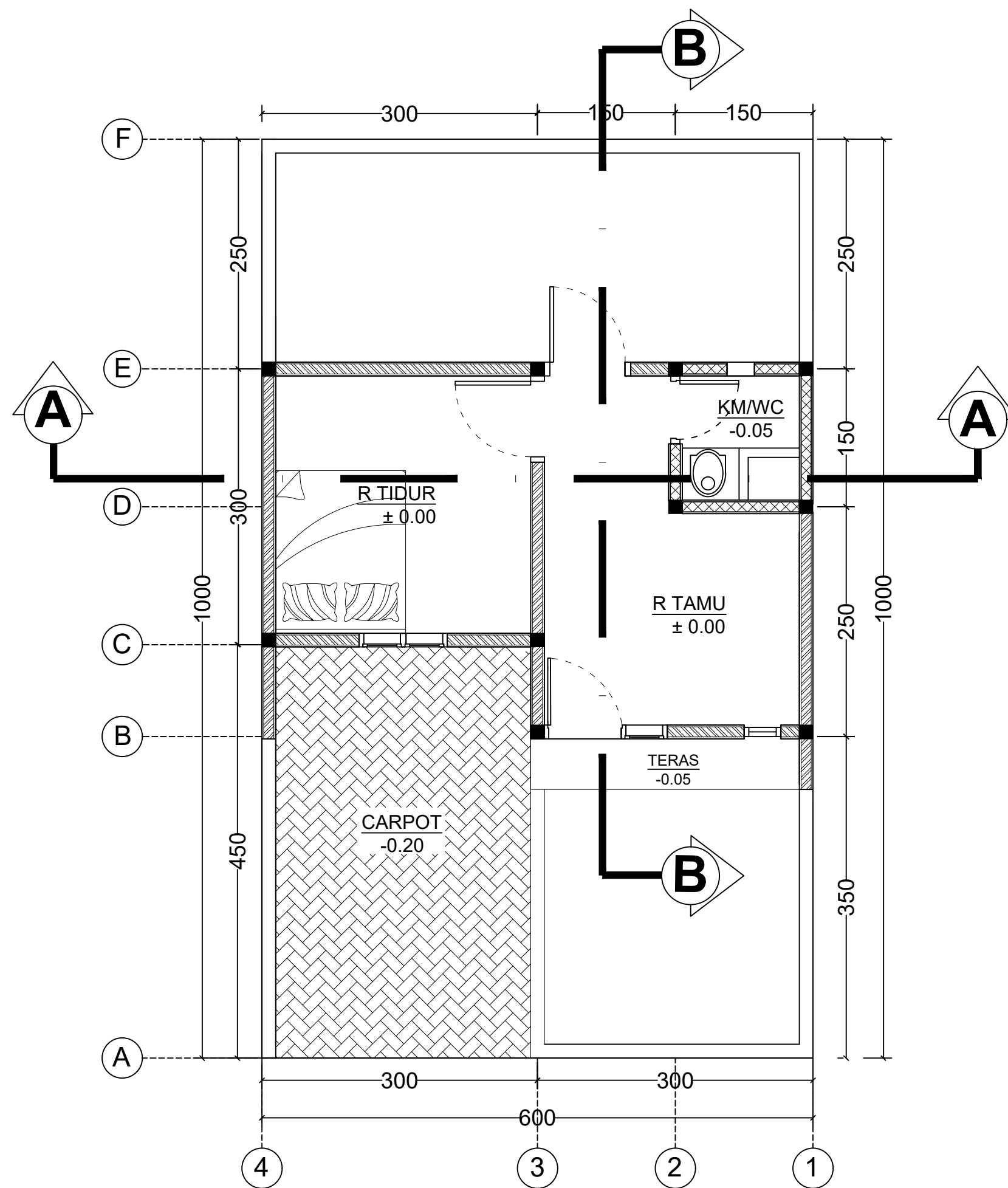

DENAH
SKALA ; 1 : 50



TAMPAK DEPAN

SKALA ; 1 : 50

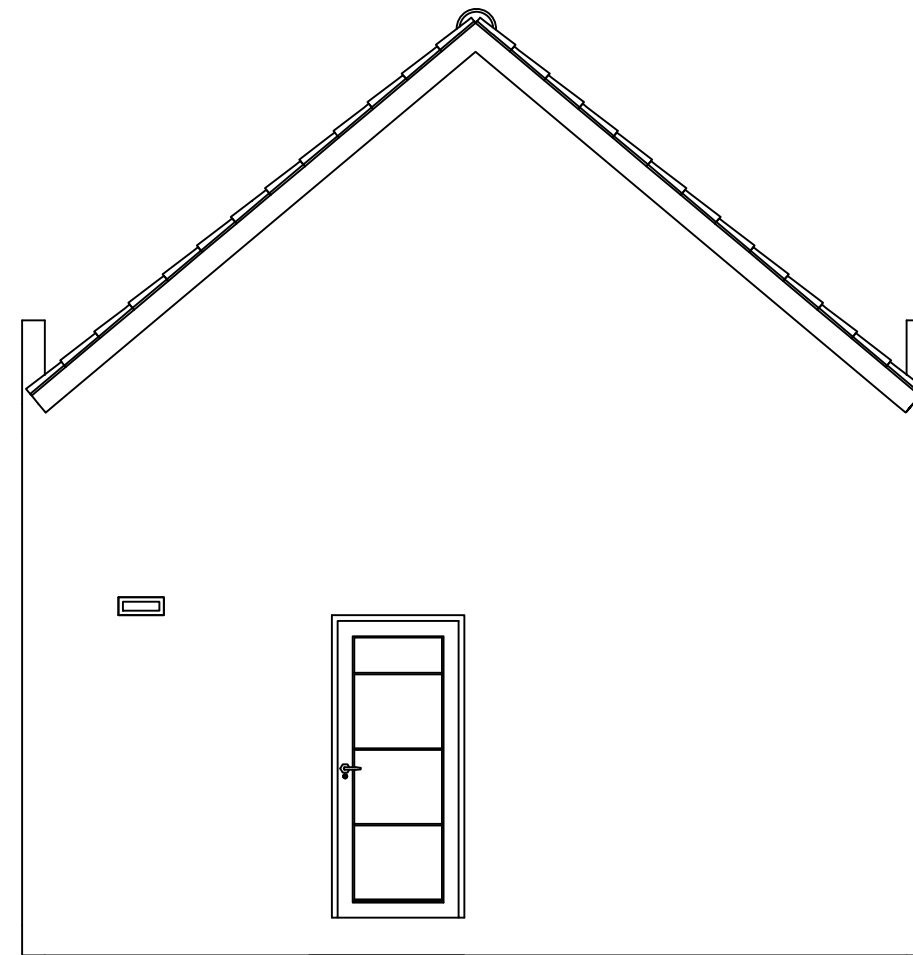

TAMPAK BELAKANG

SKALA ; 1 : 50

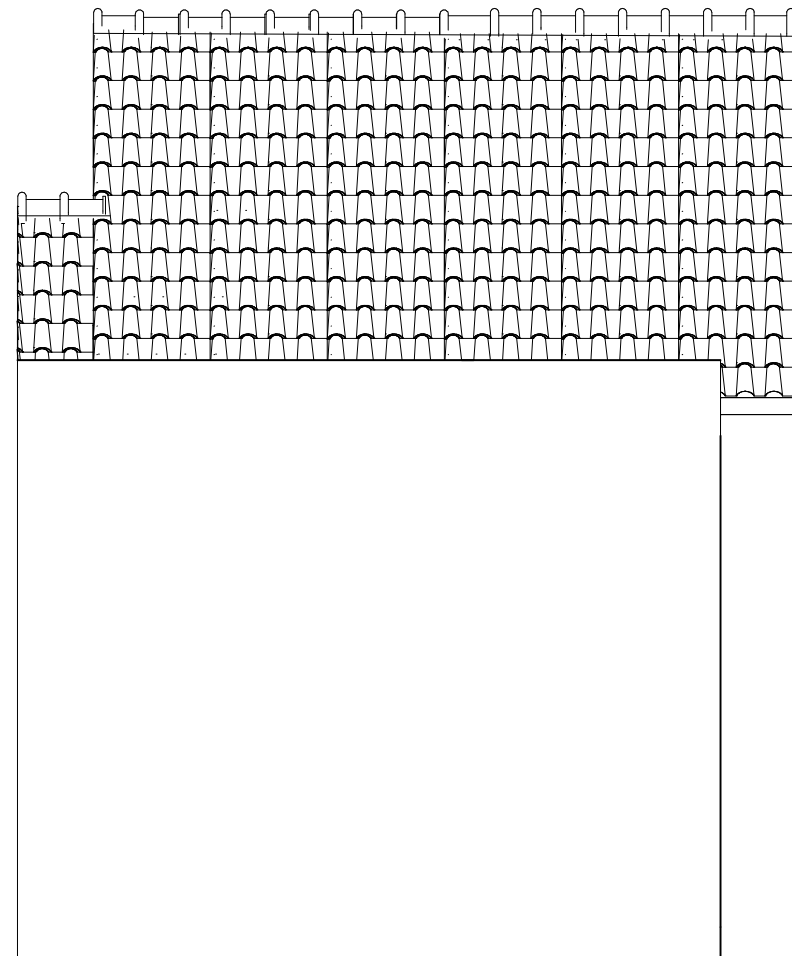

TAMPAK SAMPING KIRI

SKALA ; 1 : 50

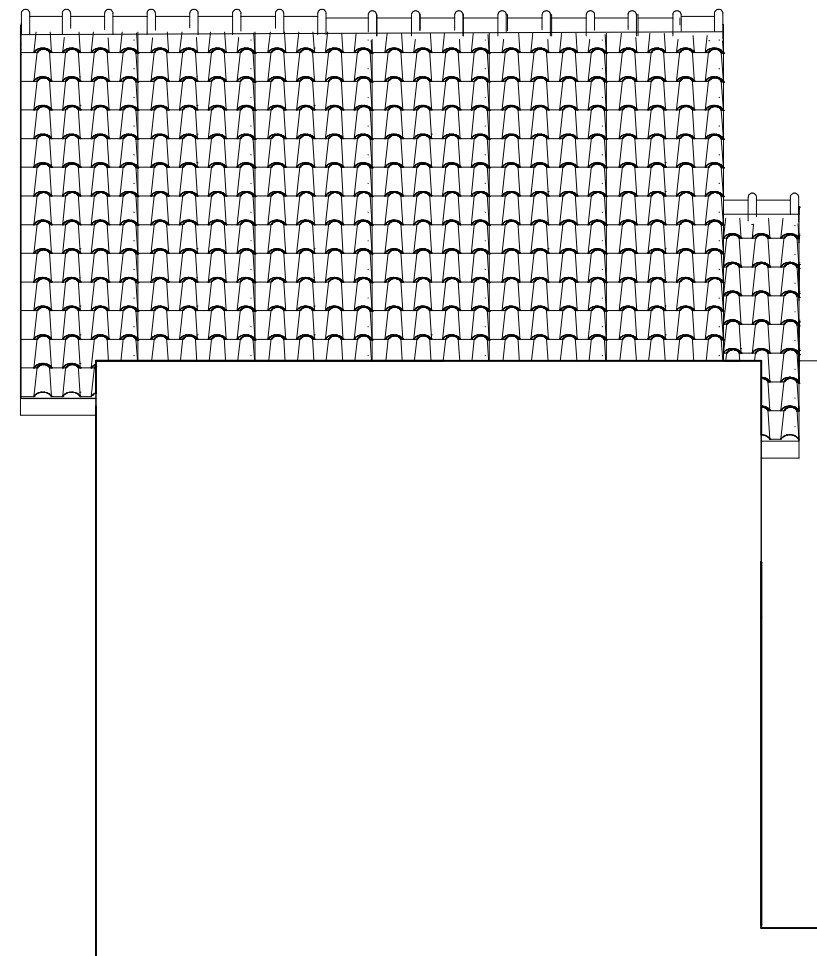

TAMPAK SAMPING KANAN

SKALA ; 1 : 50

JURUSAN SIPIL
FAKULTAS TEKNIK



UNIVERSITAS
MUHAMMADIYAH
MALANG

DOSEN PEMBIMBING

IR. YUNAN RUSDIANTO., MT
AULIA INDIRA KUMALASARI, ST., MT

NAMA MAHASISWA

AZMI WAHYU IKHSAN
(202110340311133)

RO'YATUL MAULANA S.
(202110340311108)

MOH FATIH ABDURRAHMAN
(202110340311175)

AVICENNA HARITZMI A. R.
(202110340311212)

NAMA GAMBAR

TAMPAK

SKALA GAMBAR

1 : 50

KETERANGAN

NO. GAMBAR

KERTAS

A3

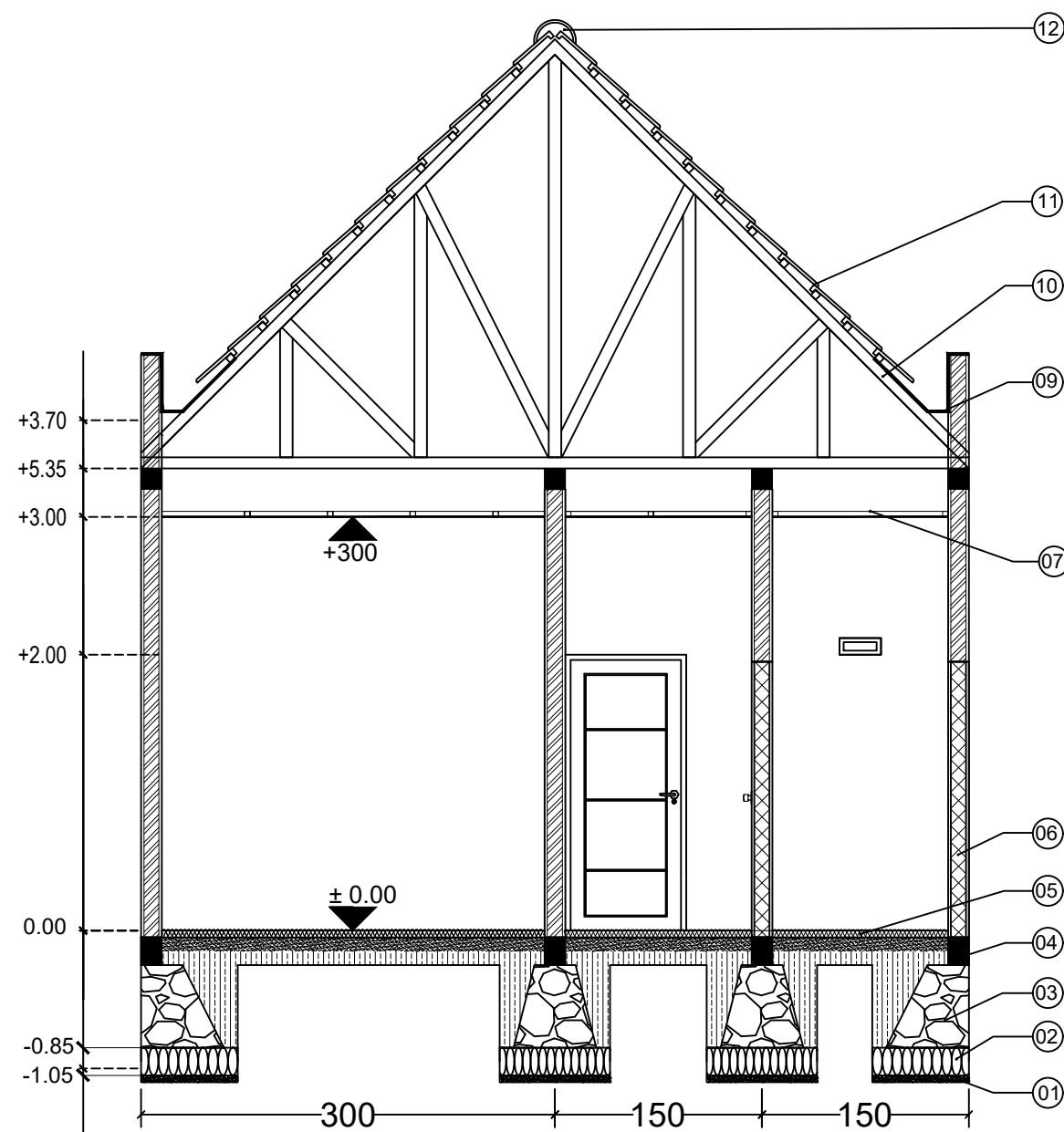

POTONGAN AA
SKALA : 1 : 50

LEGENDA:

- 1: Pasir Urug 5 cm
- 2: Aanstampeng 20 cm
- 3: Pas Batu Kali
- 4: Sloof 15/20
- 5: Keramik Lantai 30x30
- 6: Pas Dinding Bata + Plester+ Aci+Cat
- 7: Plafond Calciboard + Cat
- 8: Ring Balk
- 9: Talang Air hujan
- 10:Rangka Atap Galvalum
- 11:Genteng Beton + Cat
- 12:Bubungan Genteng Beton + Cat

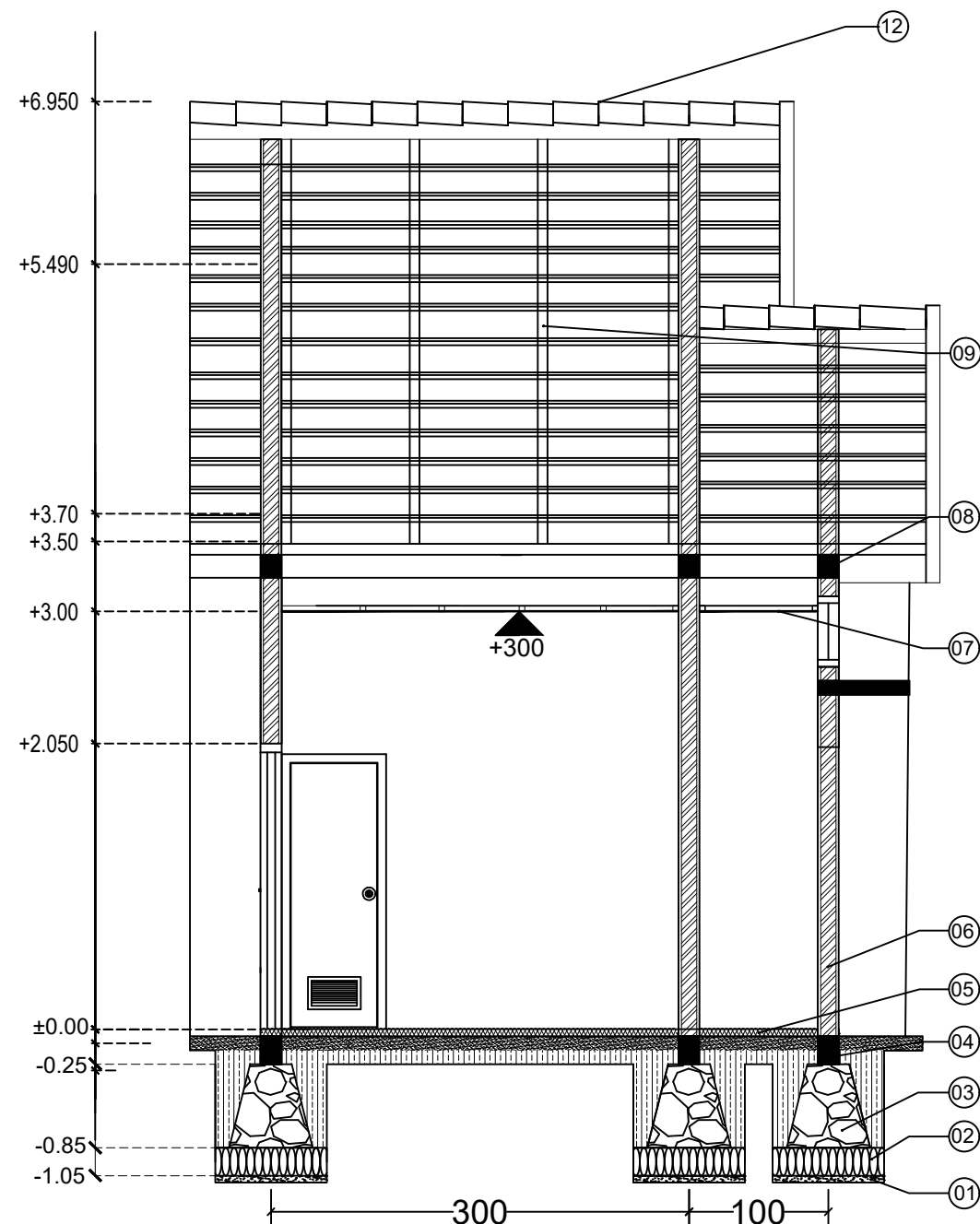

POTONGAN BB
SKALA ; 1 : 50

LEGENDA:

- 1: Pasir Urug 5 cm
- 2: Aanstampeng 20 cm
- 3: Pas Batu Kali
- 4: Sloof 15/20
- 5: Keramik Lantai 30x30
- 6: Pas Dinding Bata + Plester+ Aci+Cat
- 7: Plafond Calciboard + Cat
- 8: Ring Balk
- 9: Rangka Atap Galvalum
- 11: Genteng Beton + Cat
- 12: Bubungan Genteng Beton + Cat

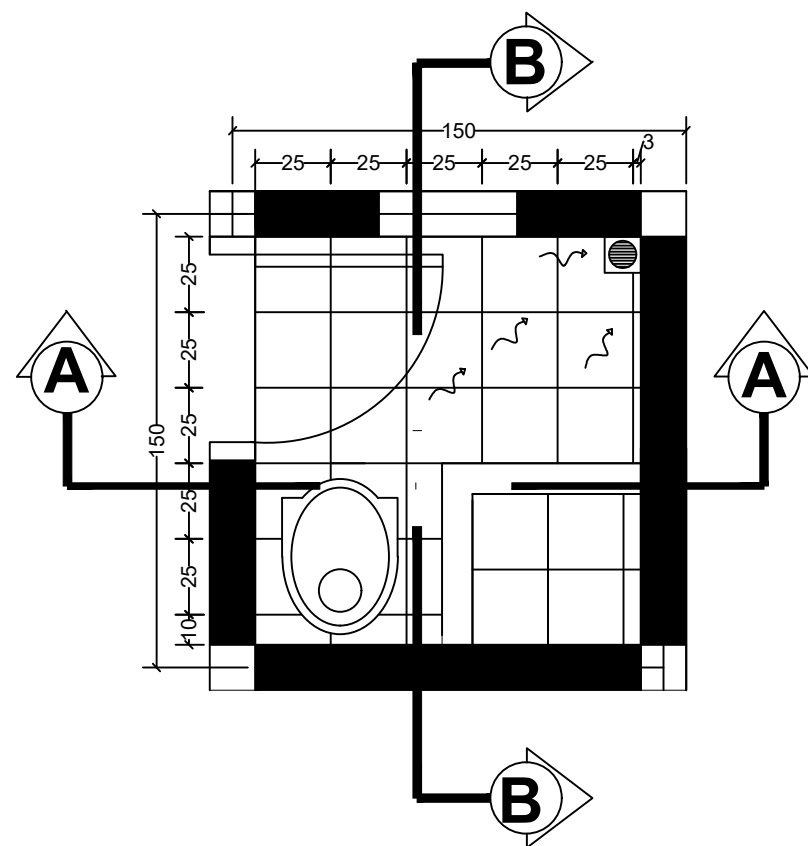

DETAIL KM/WC
SKALA ; 1 : 25

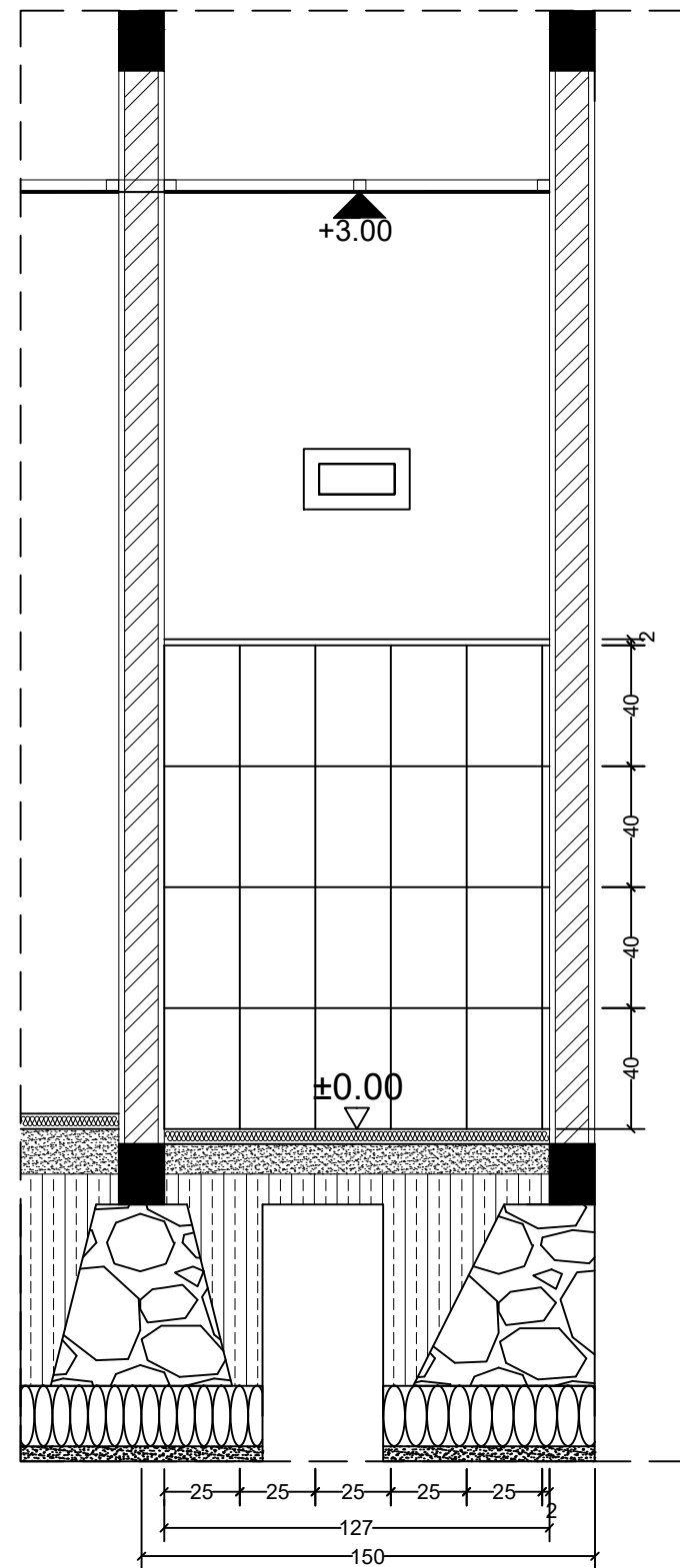

POTONGAN AA
SKALA ; 1 : 25

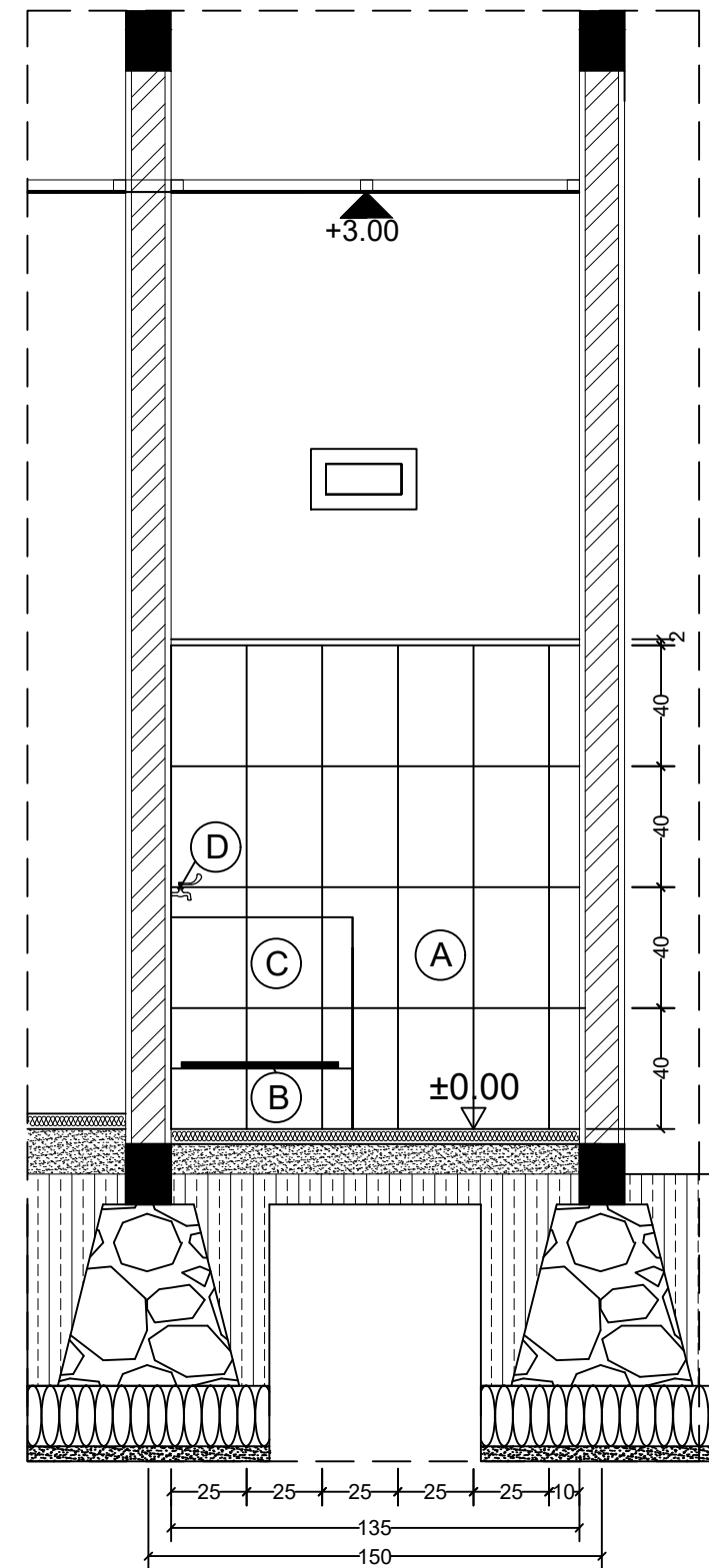

POTONGAN BB
SKALA ; 1 : 25

LEGENDA	
A	KERAMIK LANTAI 25x25
B	KERAMIK DINDING 25x40
C	CLOSET JONGKOK
D	KRAN AIR 1/2"

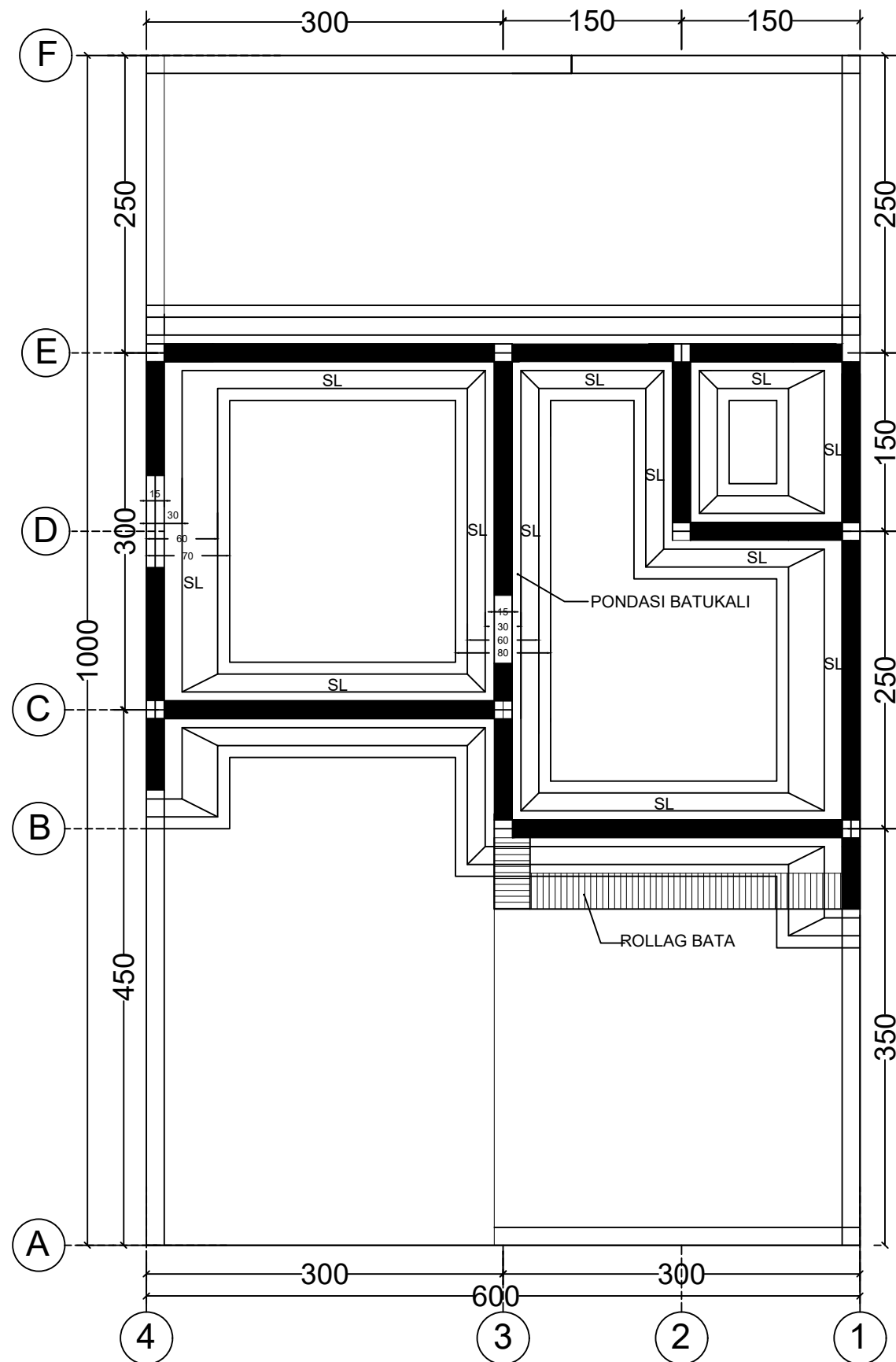

KET: SL = SLOOF 15/20

RENCANA PONDASI & SLOOF

SKALA ; 1 : 50

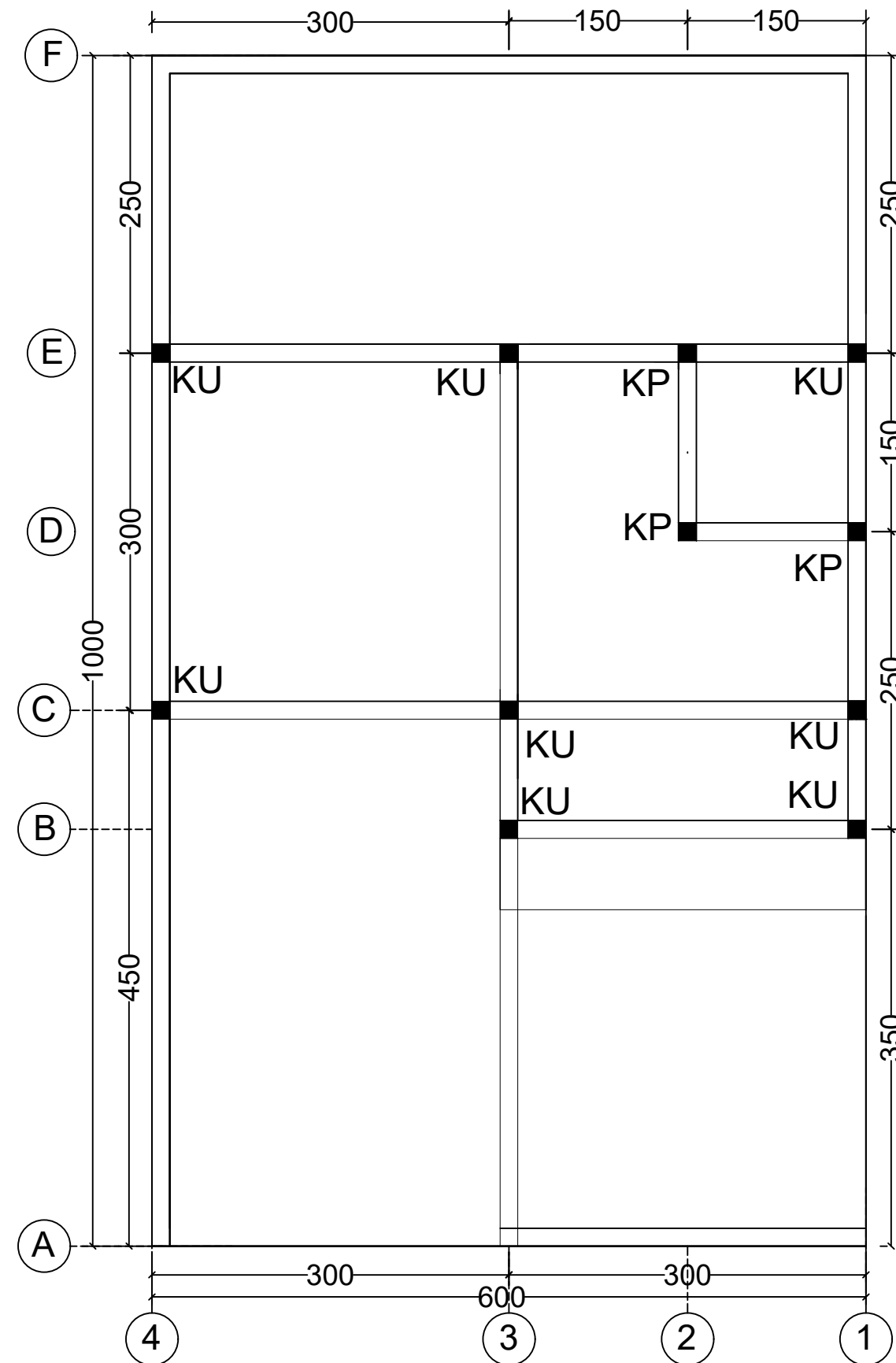

KET: KU = KOLOM UTAMA 15/15

KP = KOLOM PRAKTIS 15/15

RENCANA KOLOM

SKALA ; 1 : 50

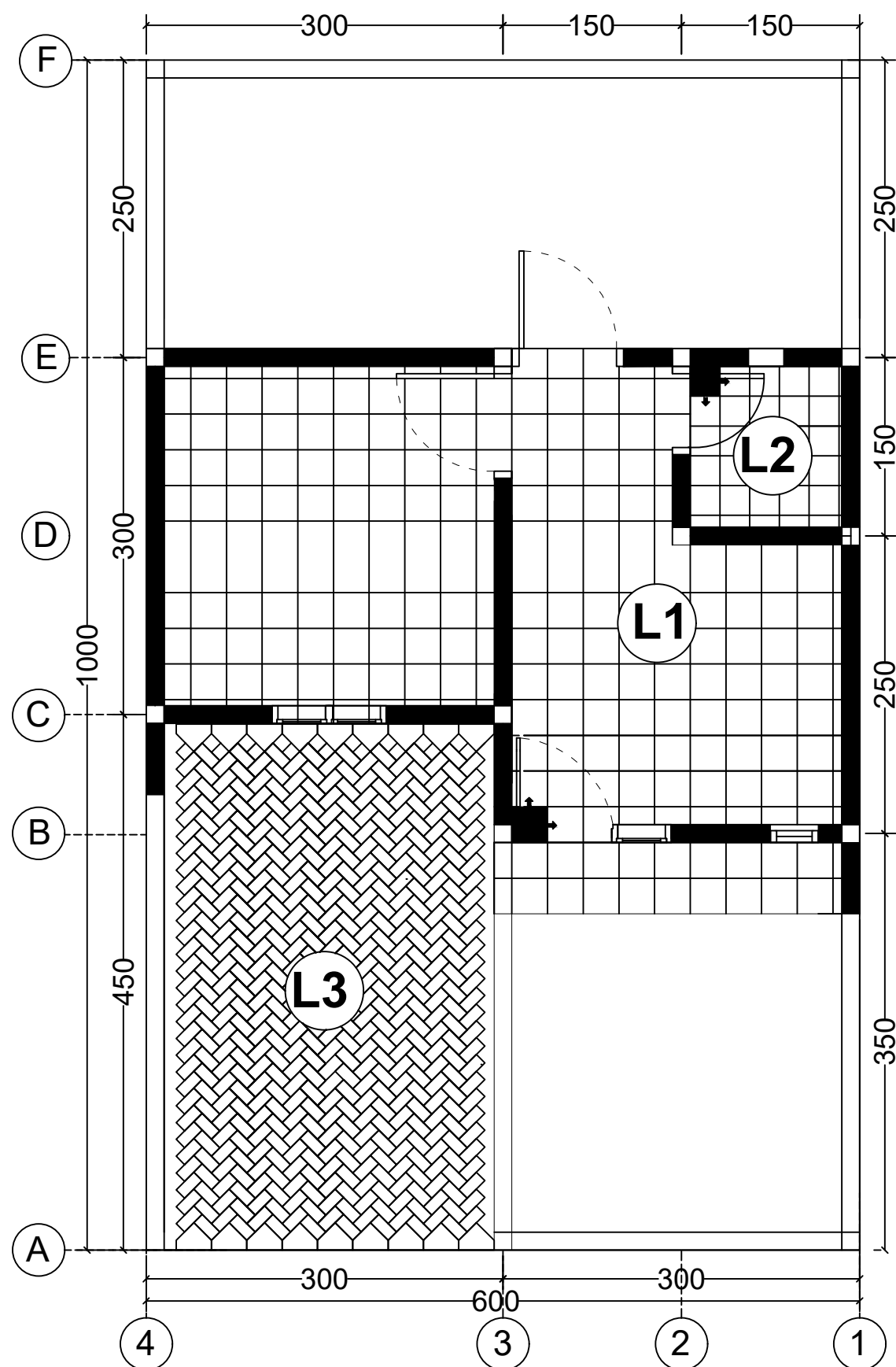

RENCANA LANTAI
SKALA : 1 : 50

LEGENDA	
L1	KERAMIK LANTAI 30X30 CM
L2	KERAMIK LANTAI 25X25 CM
L3	PAVING CARPOT

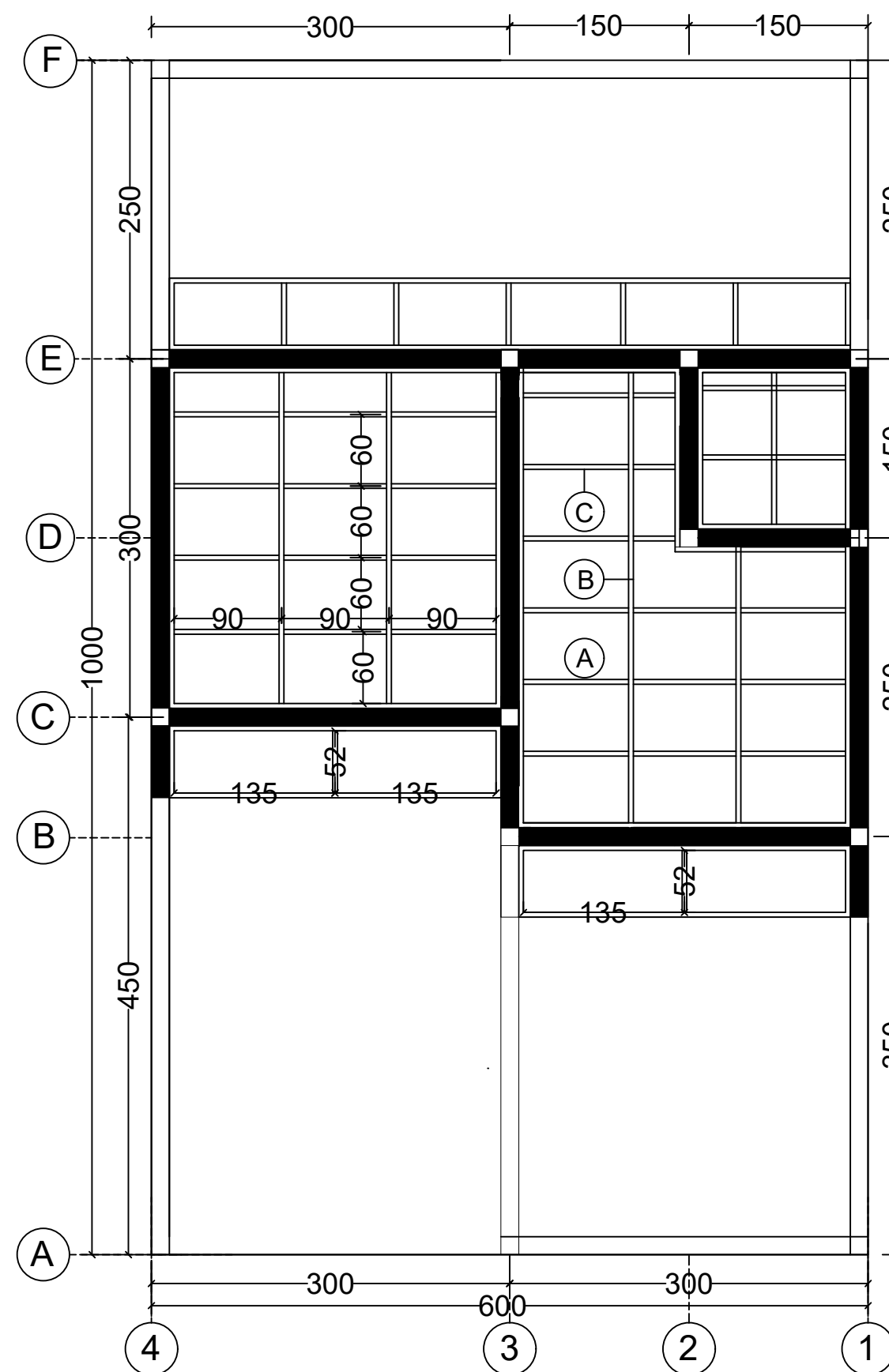

RENCANA PLAFOND
SKALA : 1 : 50

LEGENDA	
A	SILICA BOARD 8 MM
B	RANGKA KAYU 4/6 JARAK 90 CM
C	RANGKA KAYU 4/6 JARAK 60 CM

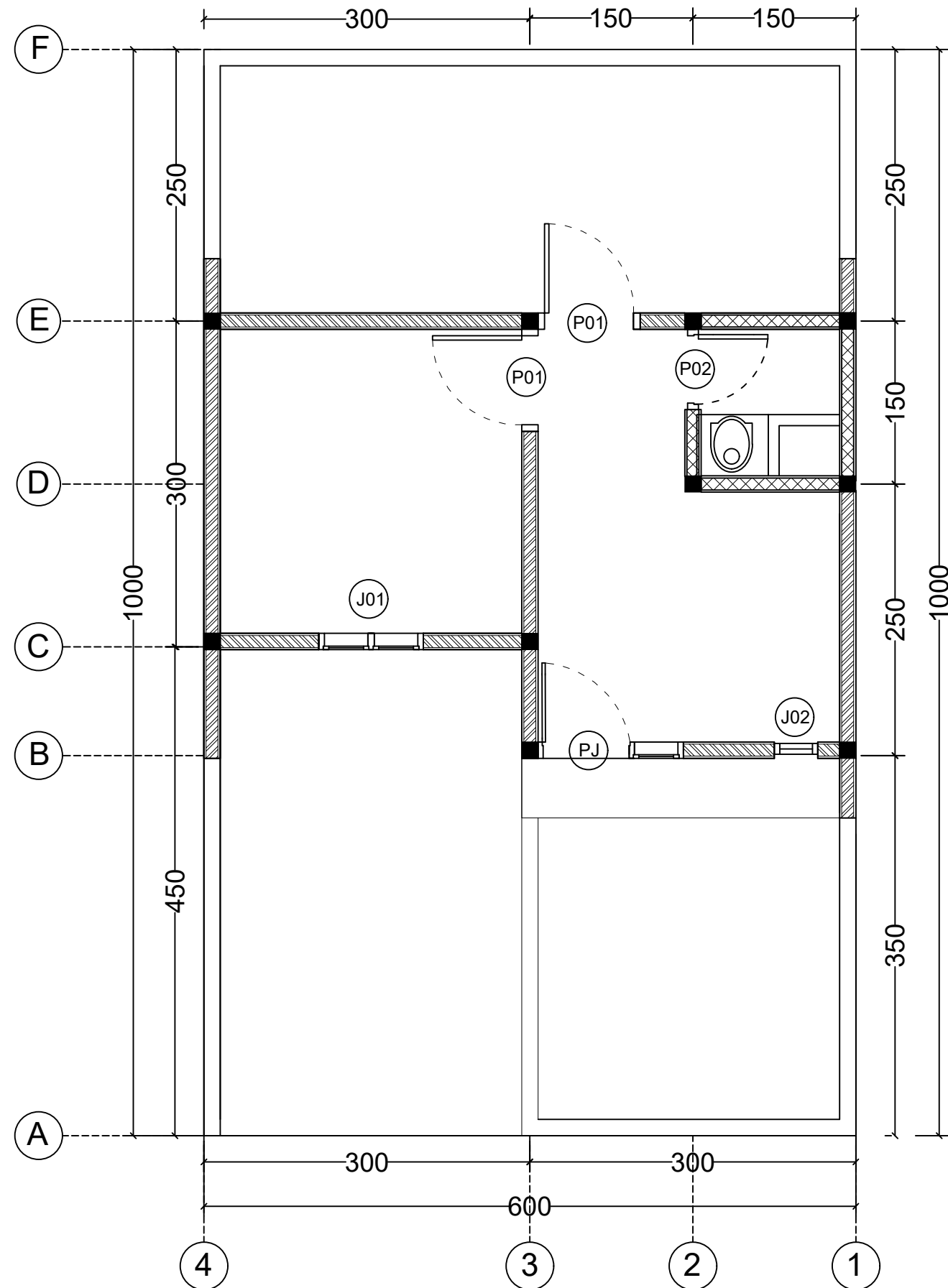

RENCANA KUSEN PINTU & JENDELA
 SKALA ; 1 : 50

JURUSAN SIPIL
 FAKULTAS TEKNIK



UNIVERSITAS
 MUHAMMADIYAH
 MALANG

DOSEN PEMBIMBING

IR. YUNAN RUSDIANTO., MT
 AULIA INDIRA KUMALASARI, ST., MT

NAMA MAHASISWA

AZMI WAHYU IKHSAN
 (202110340311133)

RO'YATUL MAULANA S.
 (202110340311108)

MOH FATIH ABDURRAHMAN
 (202110340311175)

AVICENNA HARITZMI A. R.
 (202110340311212)

NAMA GAMBAR

**RENCANA KUSEN
 PINTU & JENDELA**

SKALA GAMBAR

1 : 50

KETERANGAN

NO. GAMBAR

KERTAS

A3



RENCANA BALOK
RENCANA BALOK
GEWEL

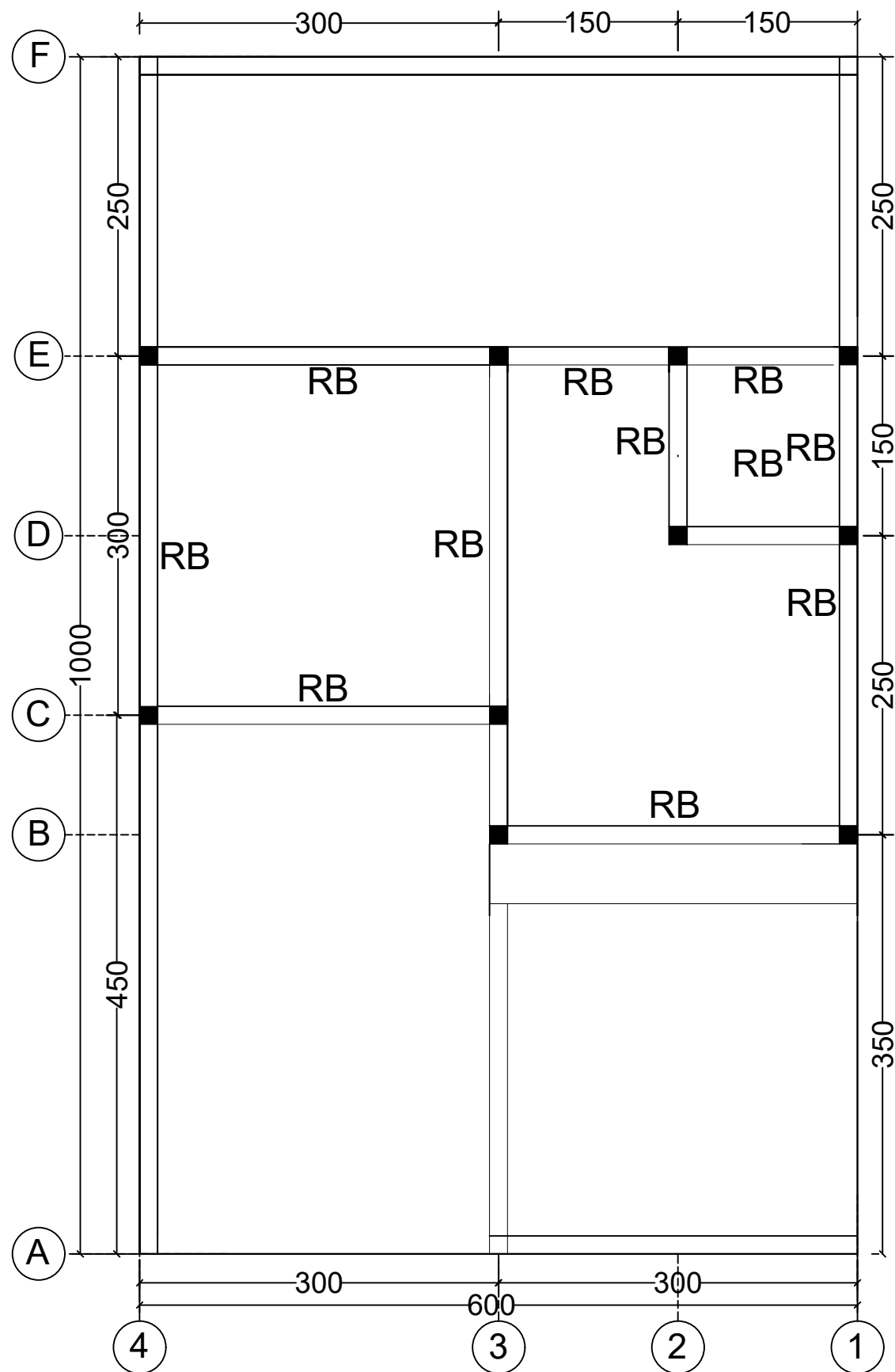

KET: RB = RING BALOK 15/20

RENCANA BALOK

SKALA ; 1 : 50

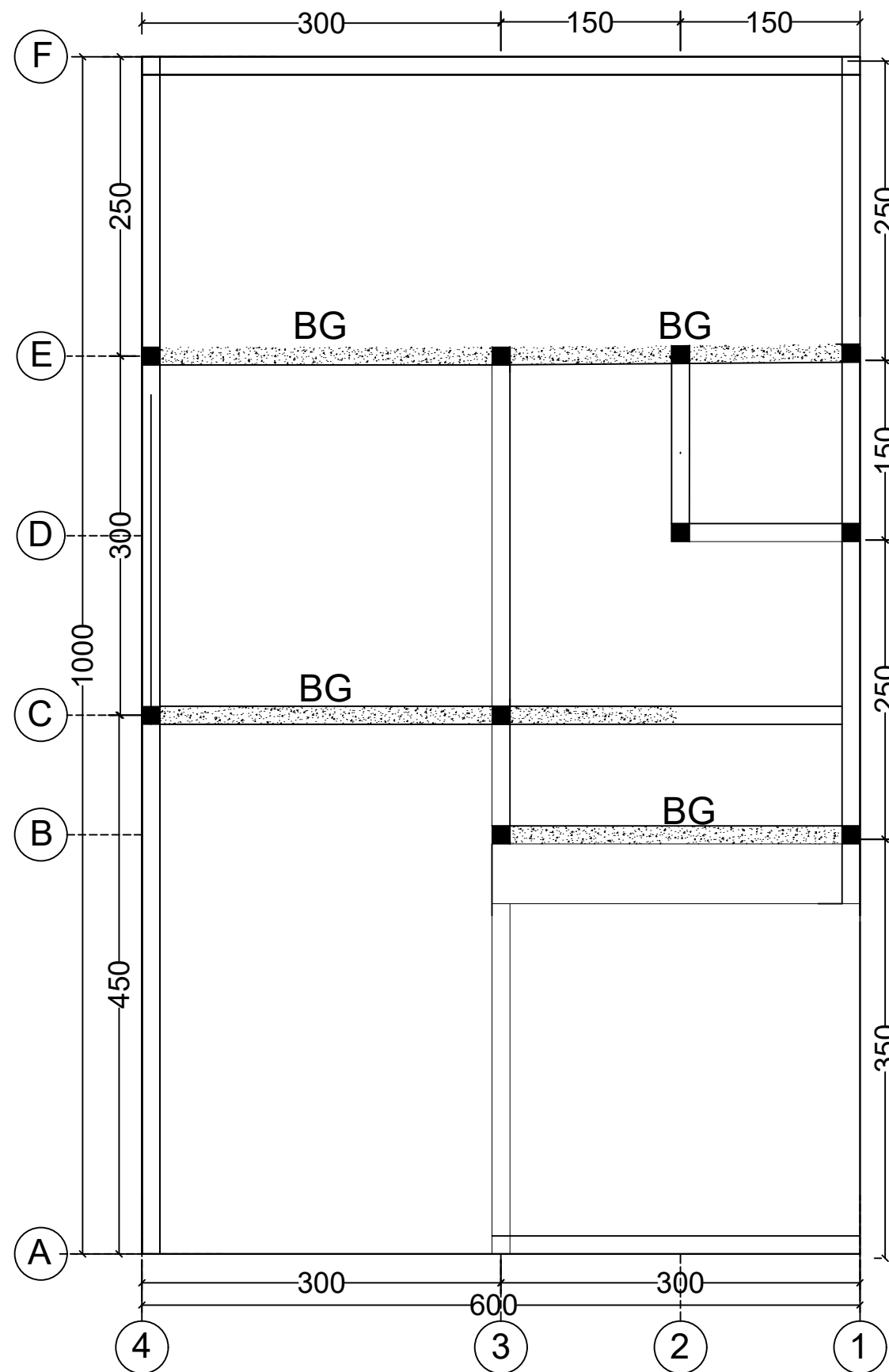

KET: BG = BALOK GEWEL

RENCANA BALOK GEWEL

SKALA ; 1 : 50

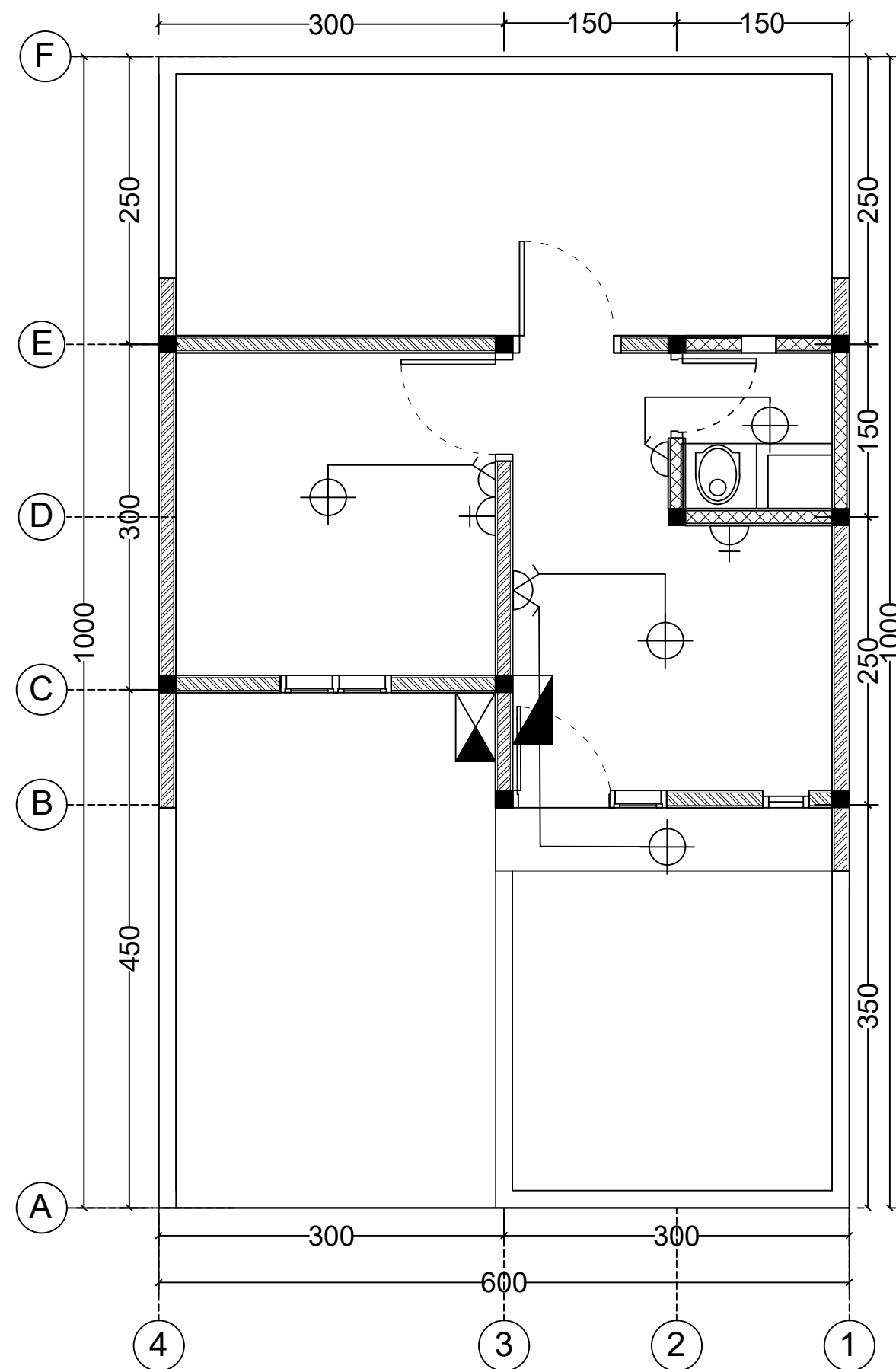

LEGENDA

	METERAN PLN
	ZEKRING
	SAKELAR TUNGGAL
	SAKELAR GANDA
	STOP KONTAK
	TITIK LAMPU 18 WATT

RENCANA TITIK LAMPU DAN STOP KONTAK
SKALA : 1 : 50

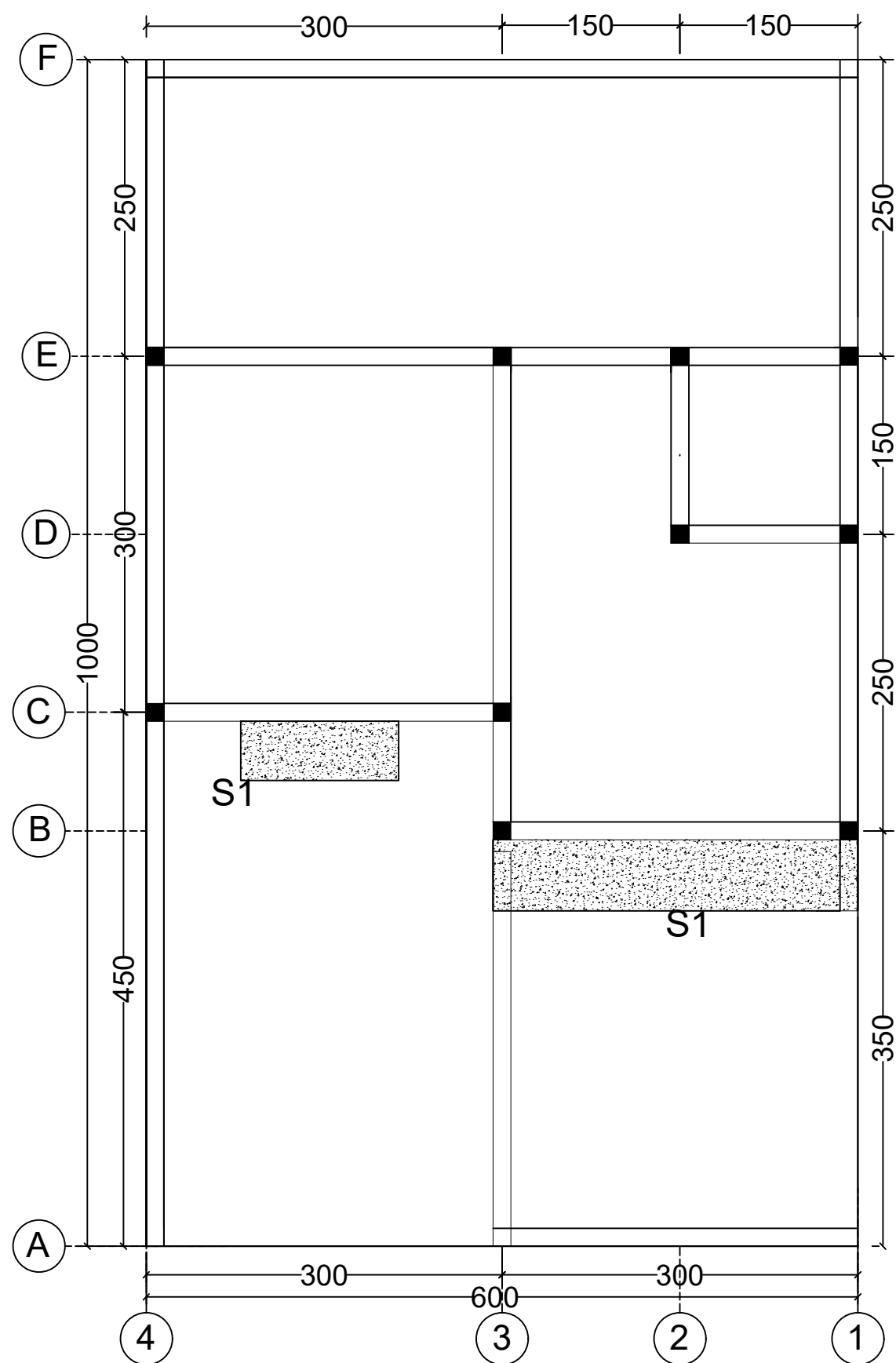

KET: S = PLAT KANOPI TEBAL 10 CM

RENCANA PLAT KANOPI
SKALA : 1 : 50

TABEL PENULANGAN

KODE BALOK	SLOOF (SL)	KOLOM (KU)	RING BALOK (R B)	BALOK GEWEL (BG)
DIMENSI (mm)	15X20	15X15	15X15	15X15
TULANGAN ATAS	2 Ø10	2 Ø10	2 Ø10	2 Ø10
PINGGANG				
TULANGAN BAWAH	2 Ø10	2 Ø10	2 Ø10	2 Ø10
SENGKANG	Ø 8 - 200	Ø 8 - 200	Ø 8 - 200	Ø 8 - 200

DETAIL PENULANGAN
SKALA : 1 : 25

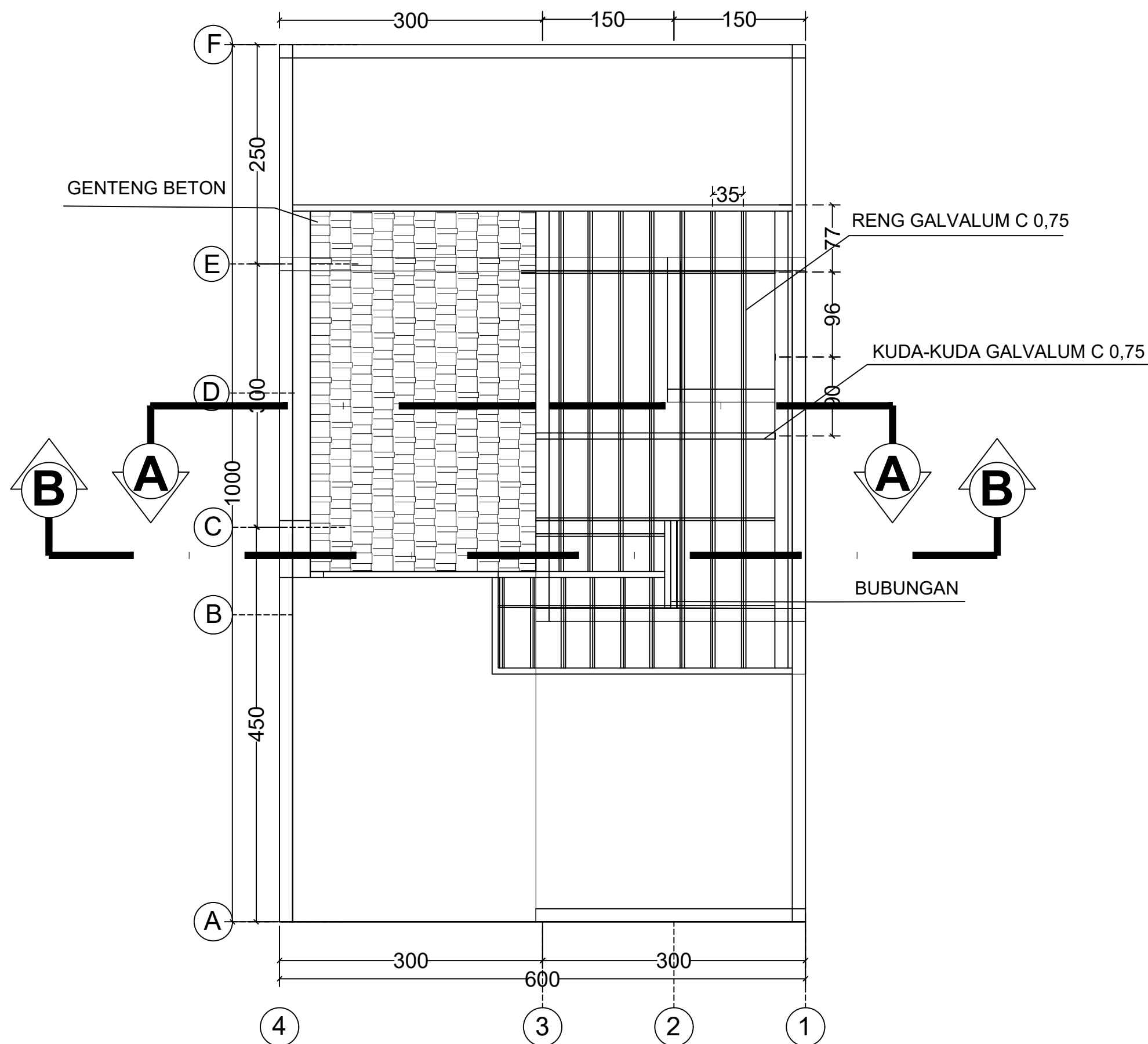

RENCANA ATAP
SKALA ; 1 : 50

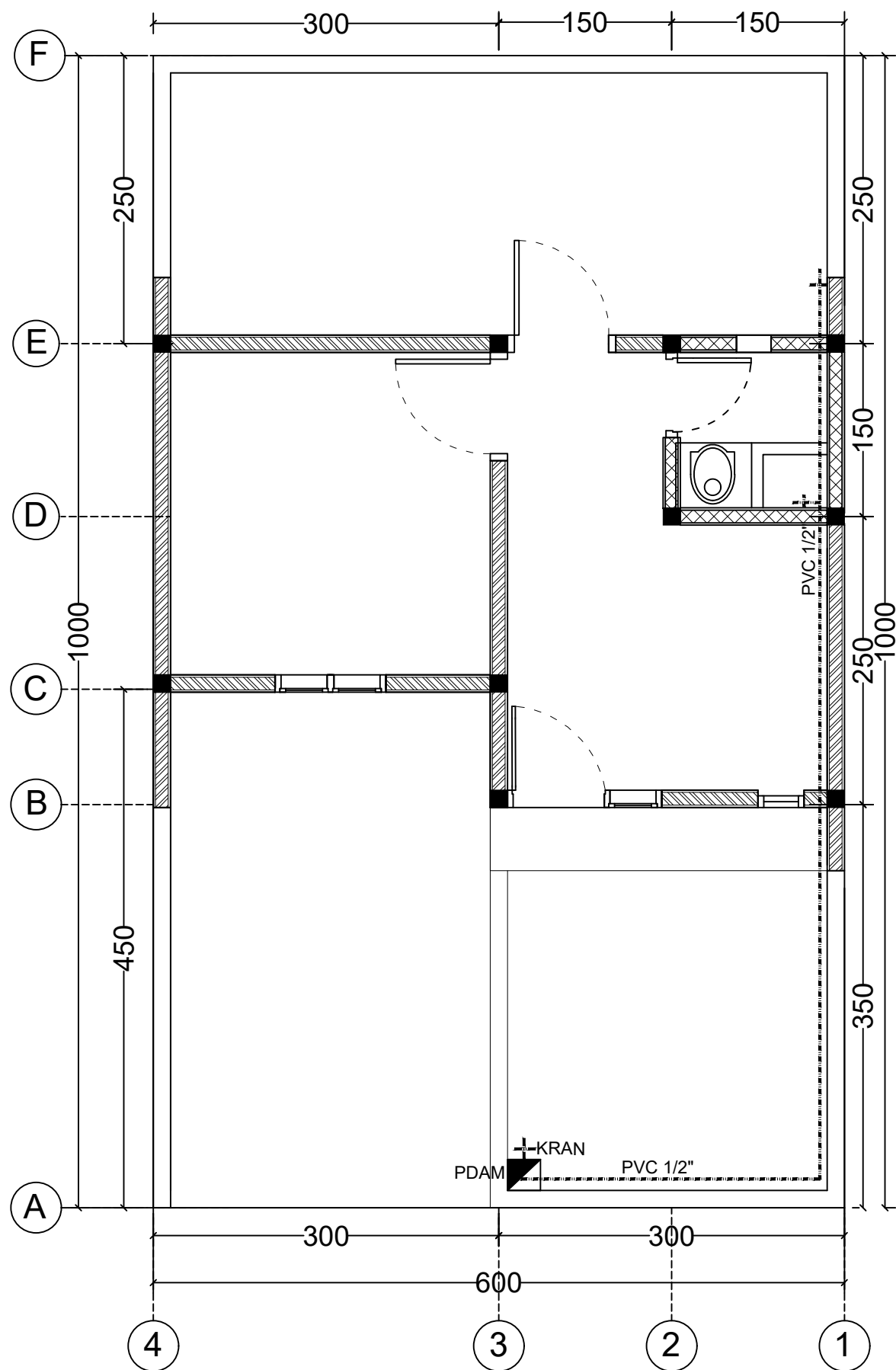

RENCANA AIR BERSIH
SKALA : 1 : 50

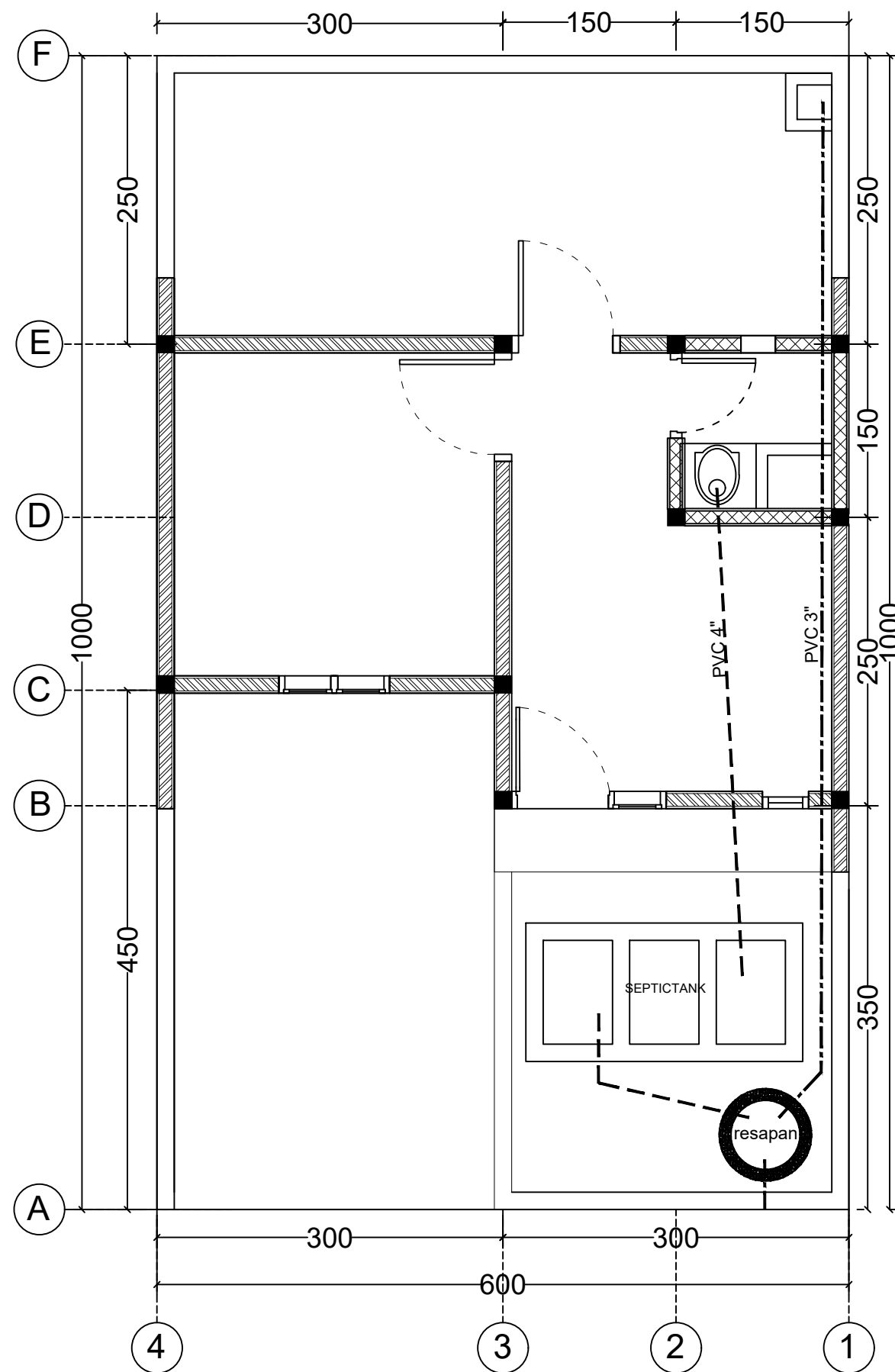

RENCANA AIR KOTOR
SKALA : 1 : 50

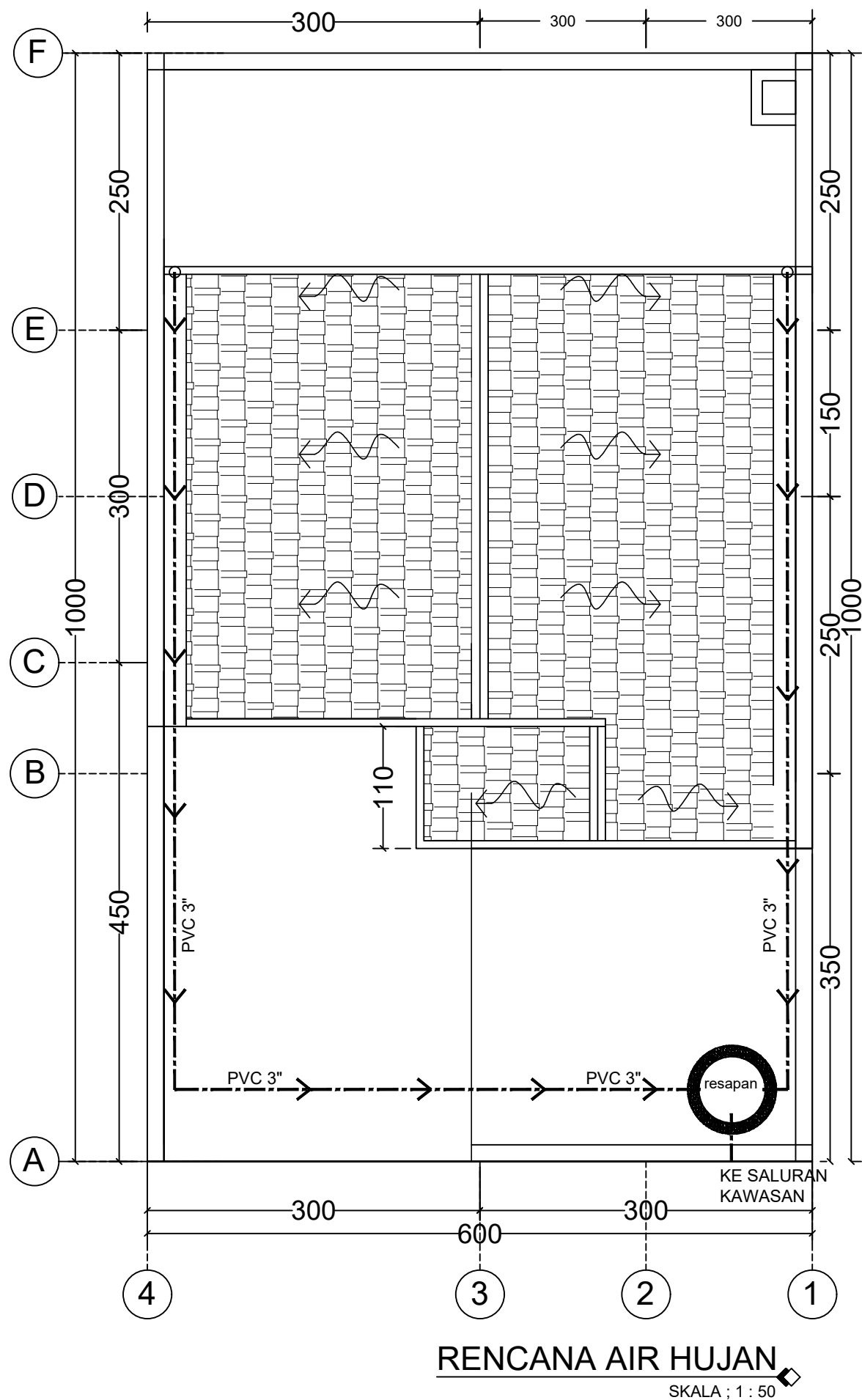

RENCANA AIR HUJAN
SKALA : 1 : 50

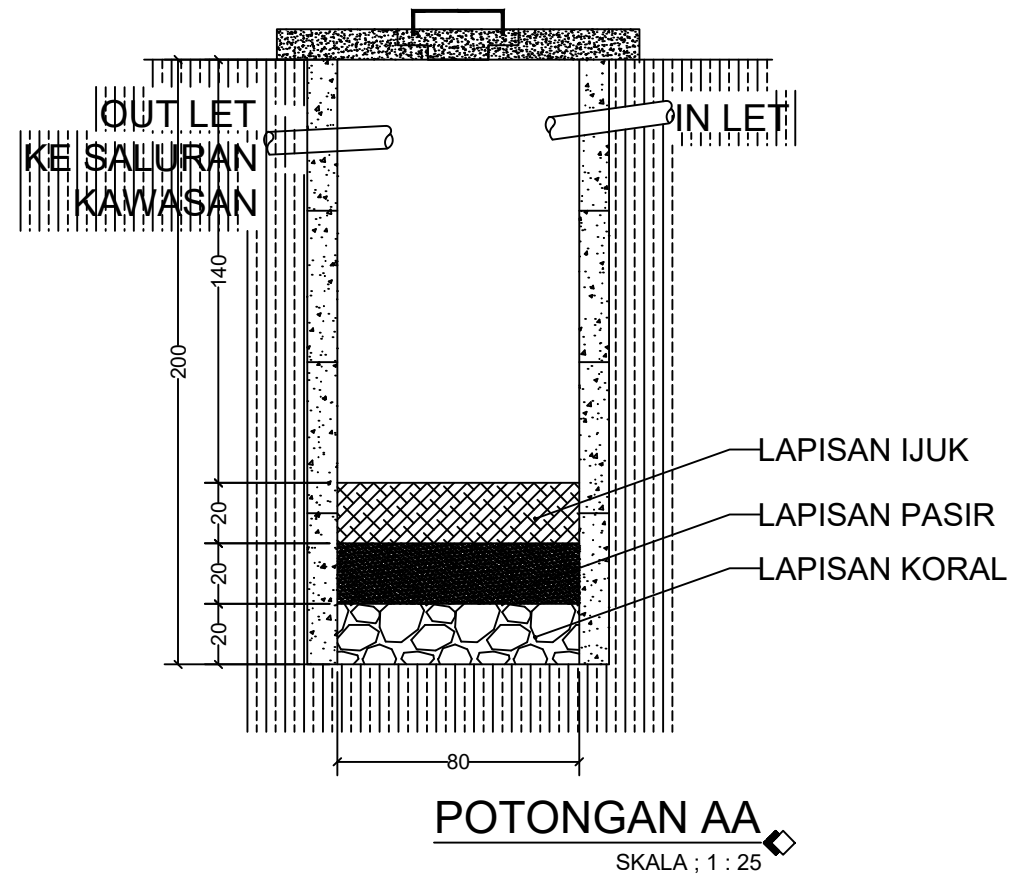

POTONGAN AA
SKALA : 1 : 25

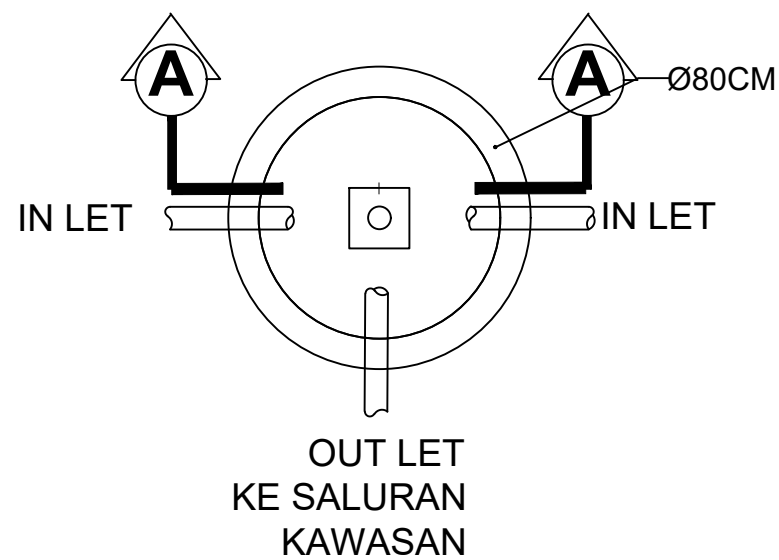

DETAIL RESAPAN AIR HUJAN
SKALA : 1 : 25

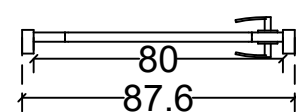
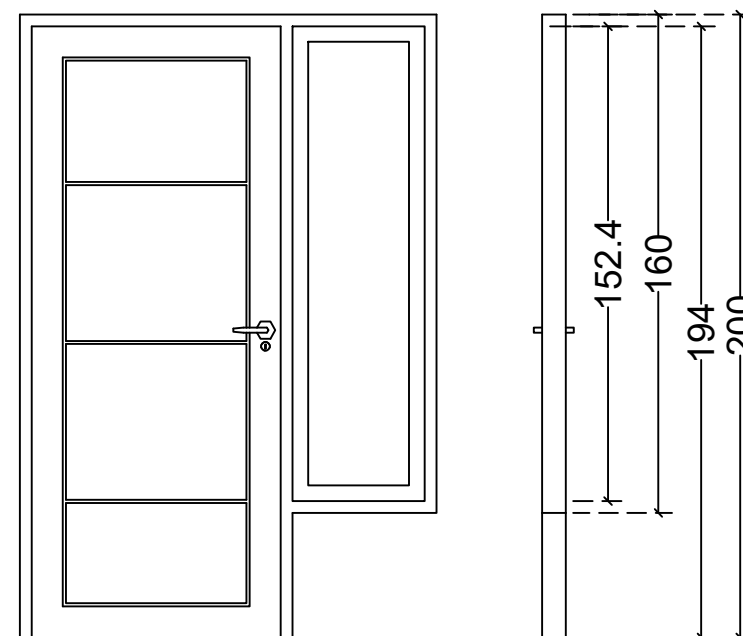
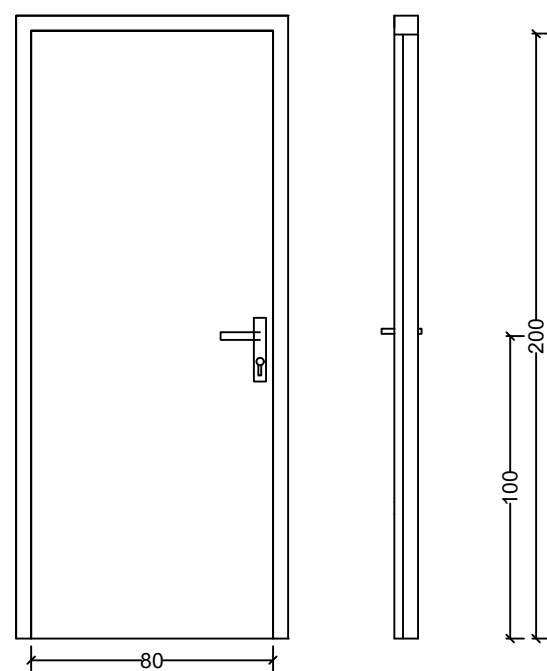

DETAIL P 01
SKALA ; 1 : 25

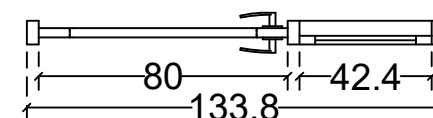

DETAIL PJ
SKALA ; 1 : 25

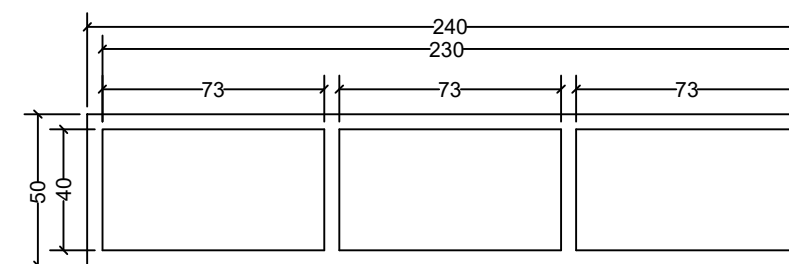
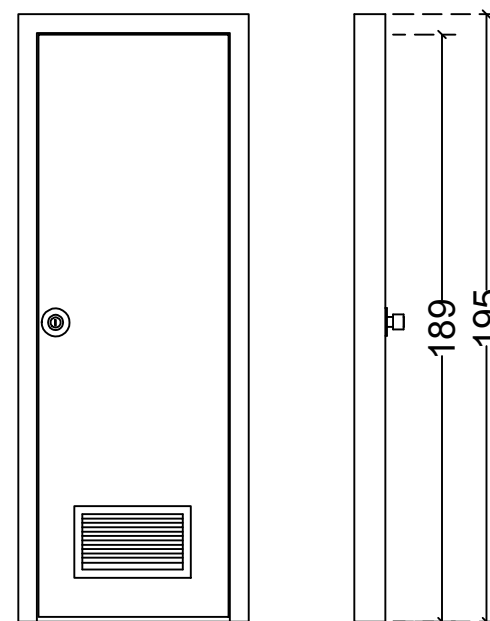
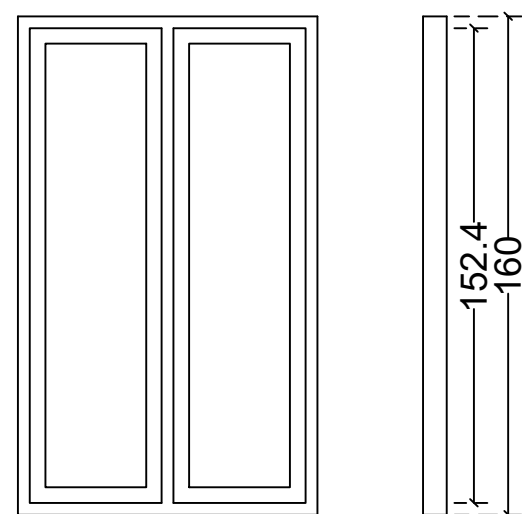

DETAIL VENTILASI KACA
SKALA ; 1 : 25

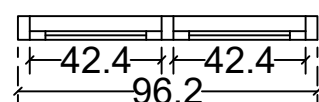

DETAIL J 01
SKALA ; 1 : 25

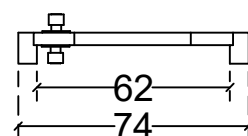

DETAIL J 02
SKALA ; 1 : 25

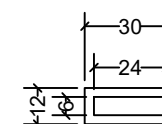

DETAIL VENTILASI KM
SKALA ; 1 : 25

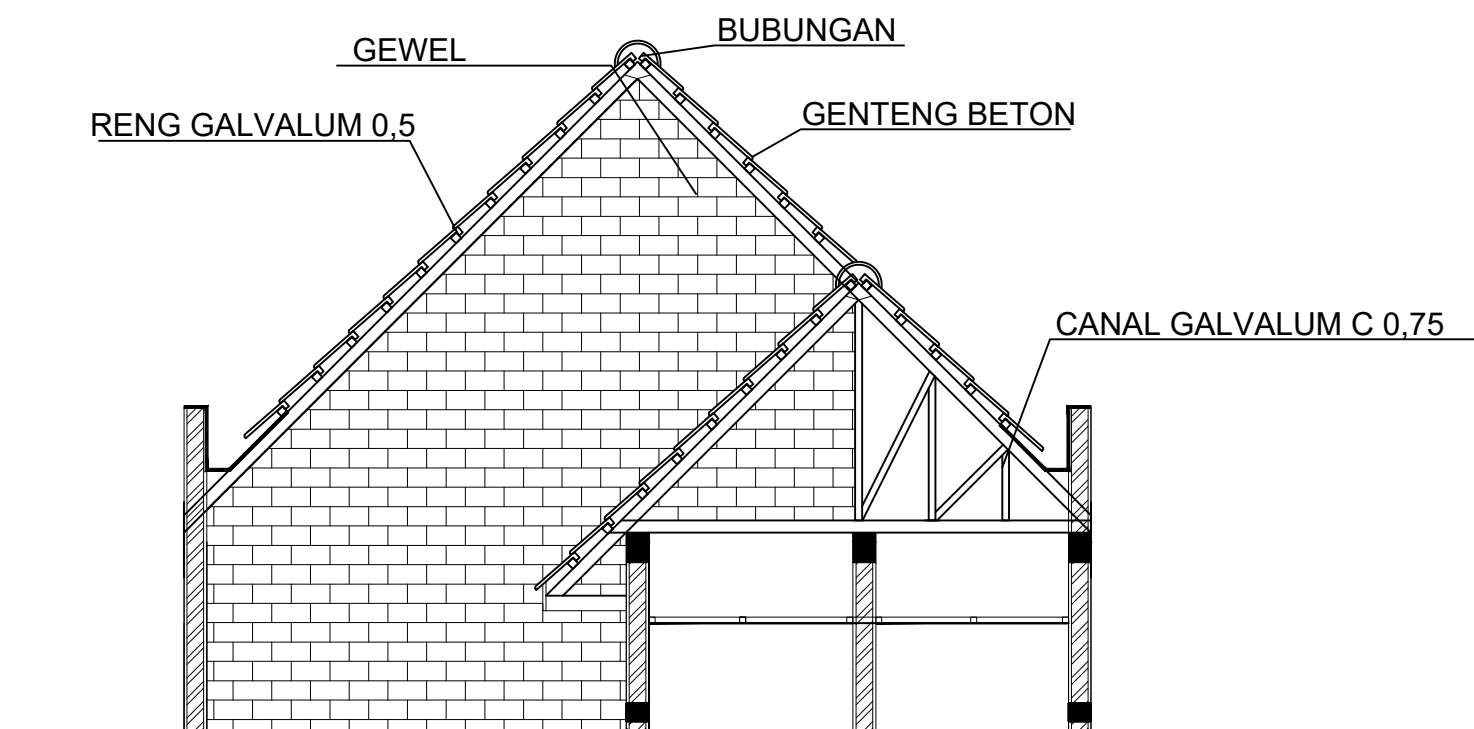

DETAIL POTONGAN KUDA KUDA BB
SKALA ; 1 : 50

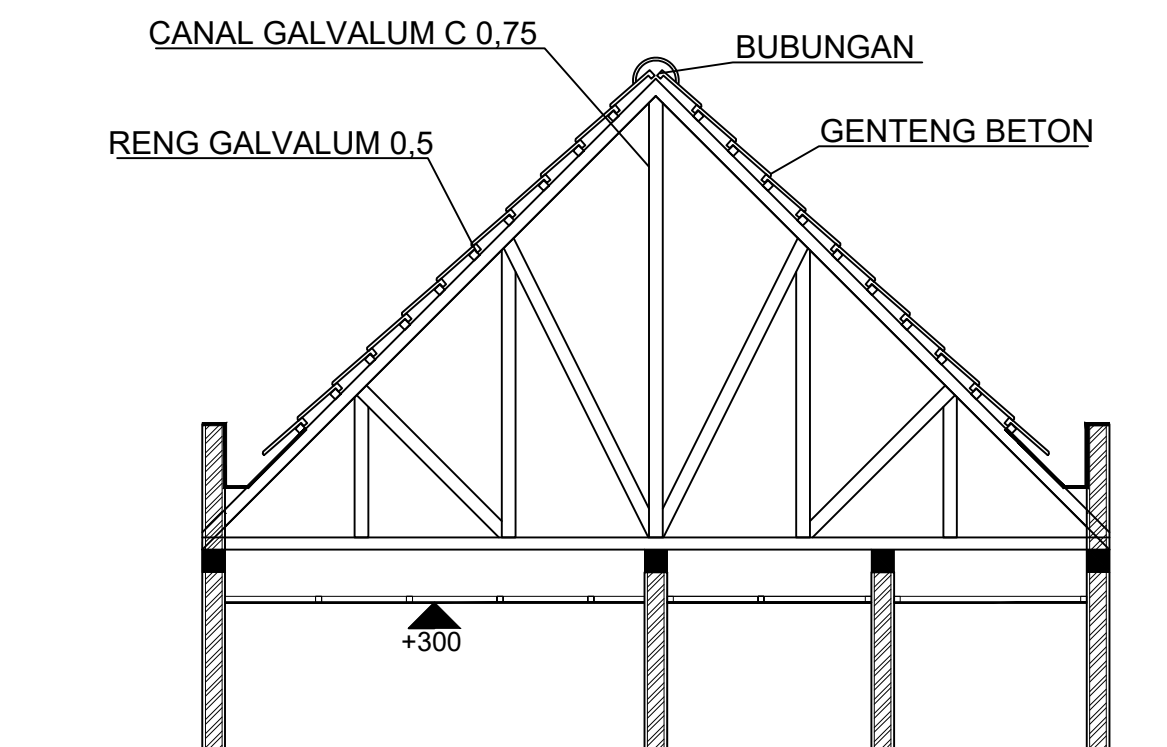

DETAIL POTONGAN KUDA KUDA AA
SKALA ; 1 : 50

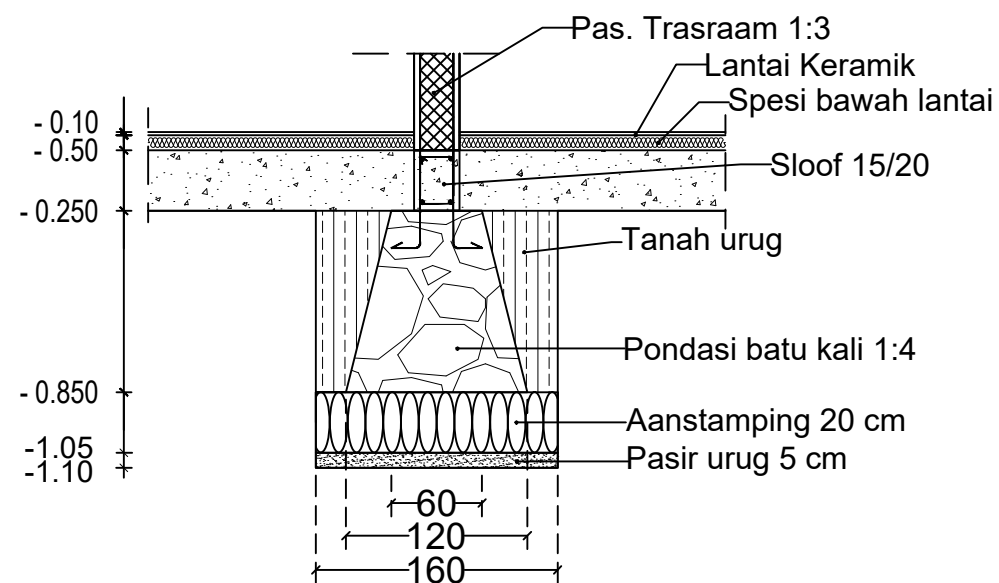

DETAIL PONDASI A
SKALA ; 1 : 25

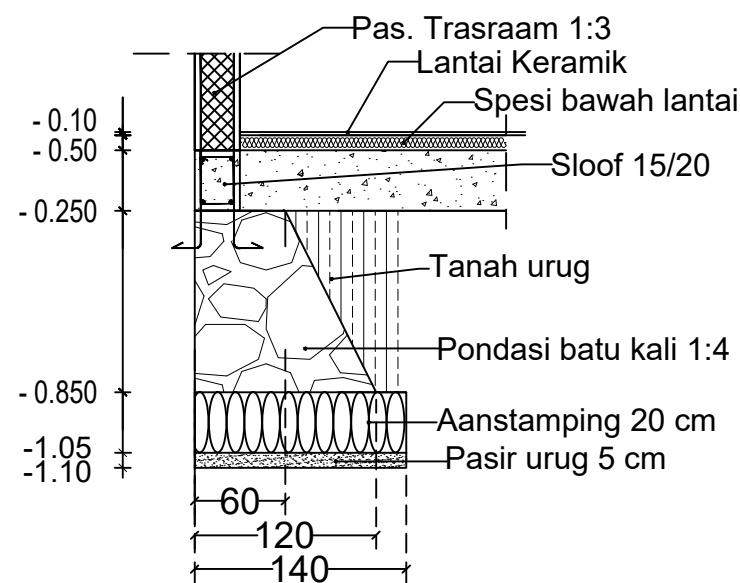

DETAIL PONDASI B
SKALA ; 1 : 25

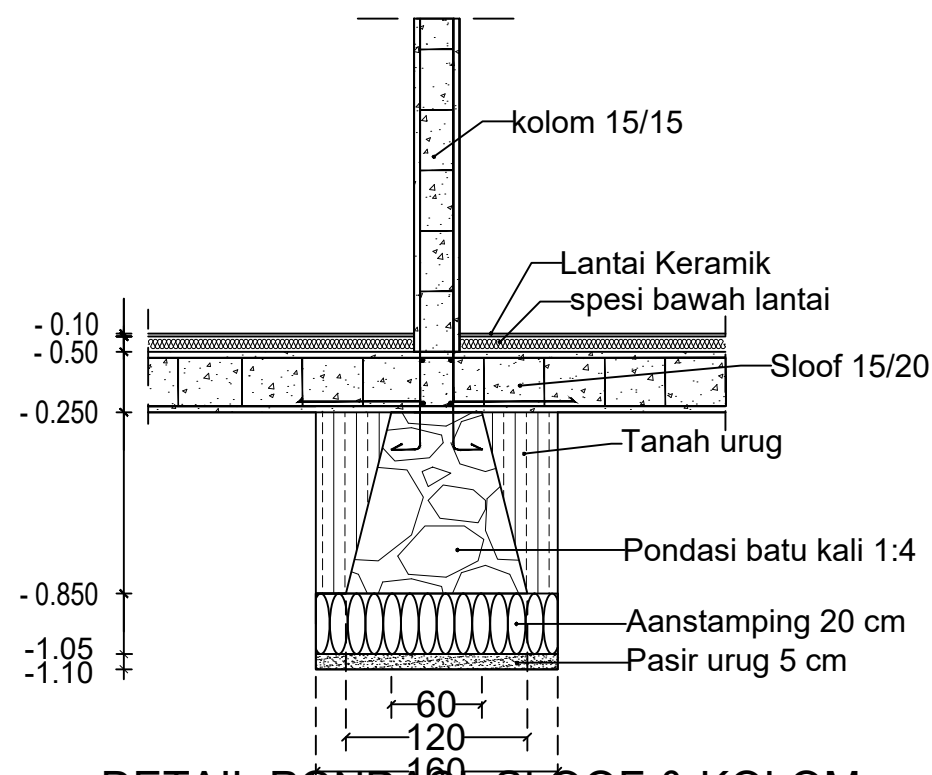

DETAIL PONDASI, SLOOF & KOLOM
SKALA ; 1 : 25

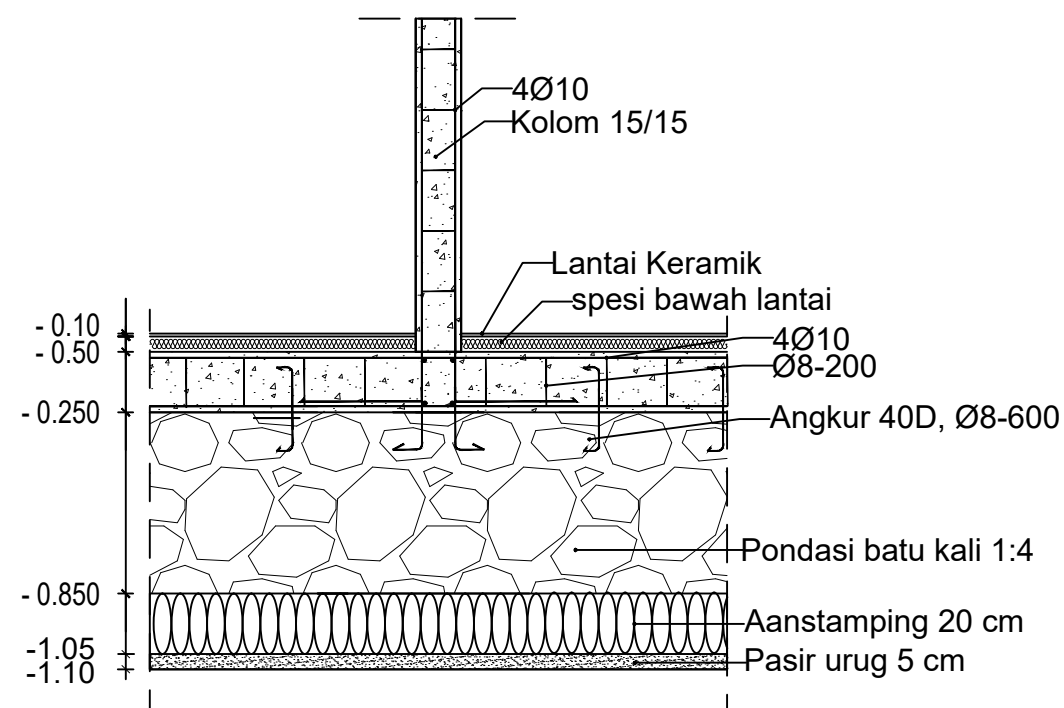

PEMBESIAN KOLOM, SLOOF & PONDASI
SKALA ; 1 : 25

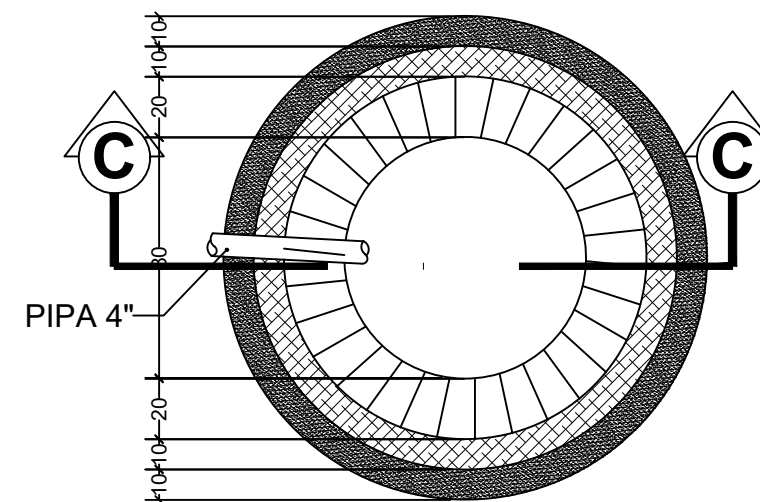
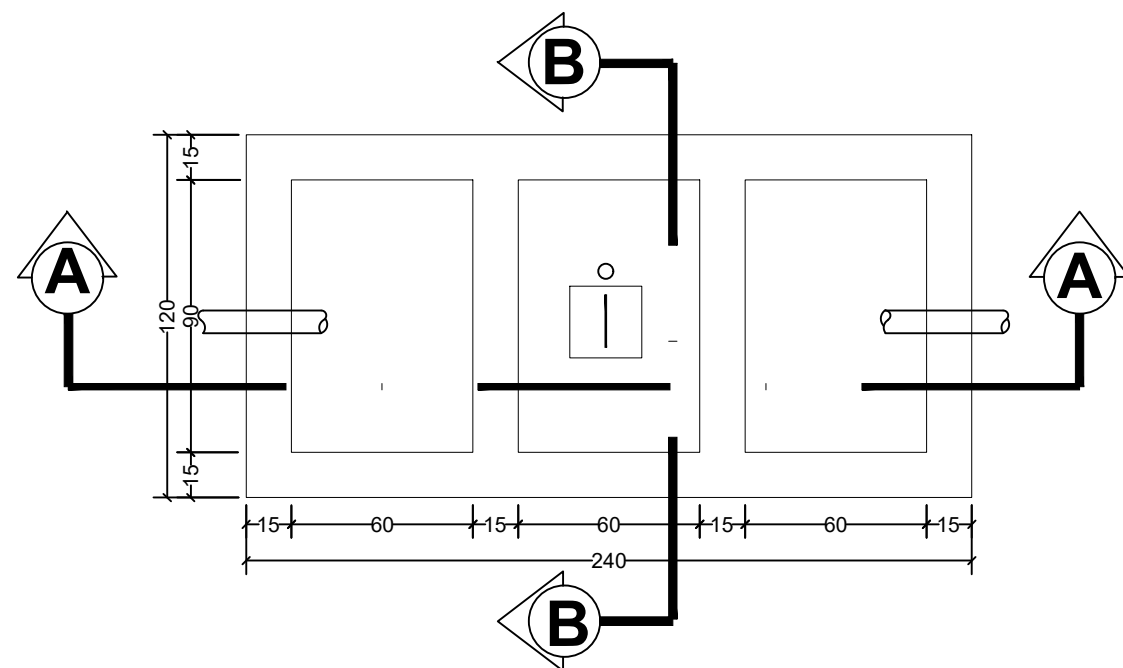
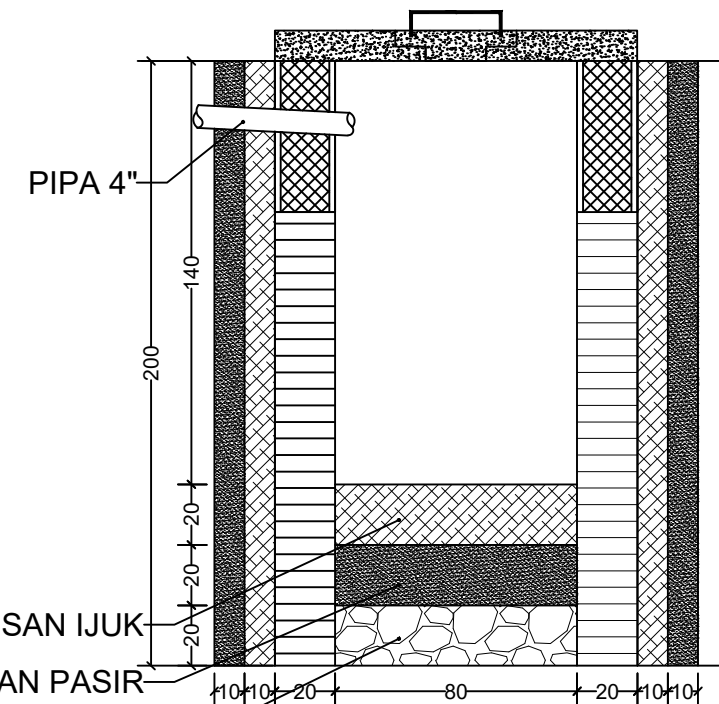
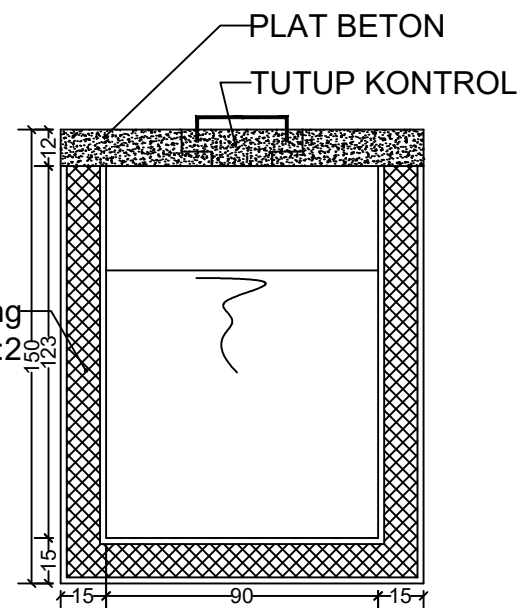
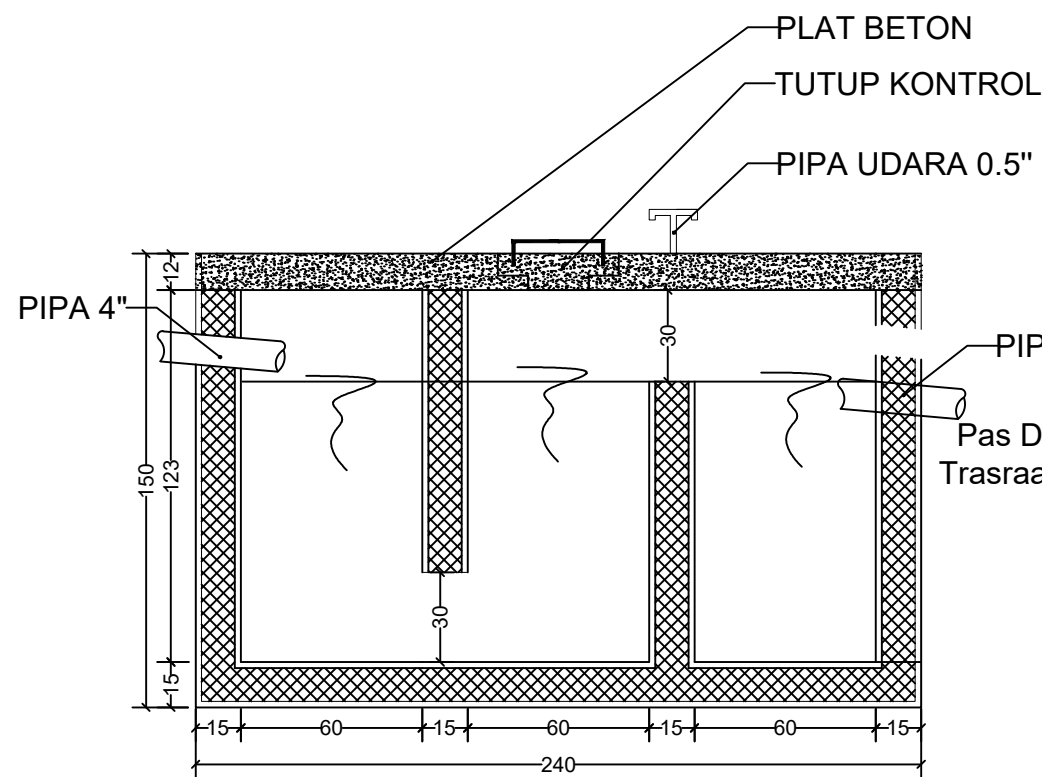

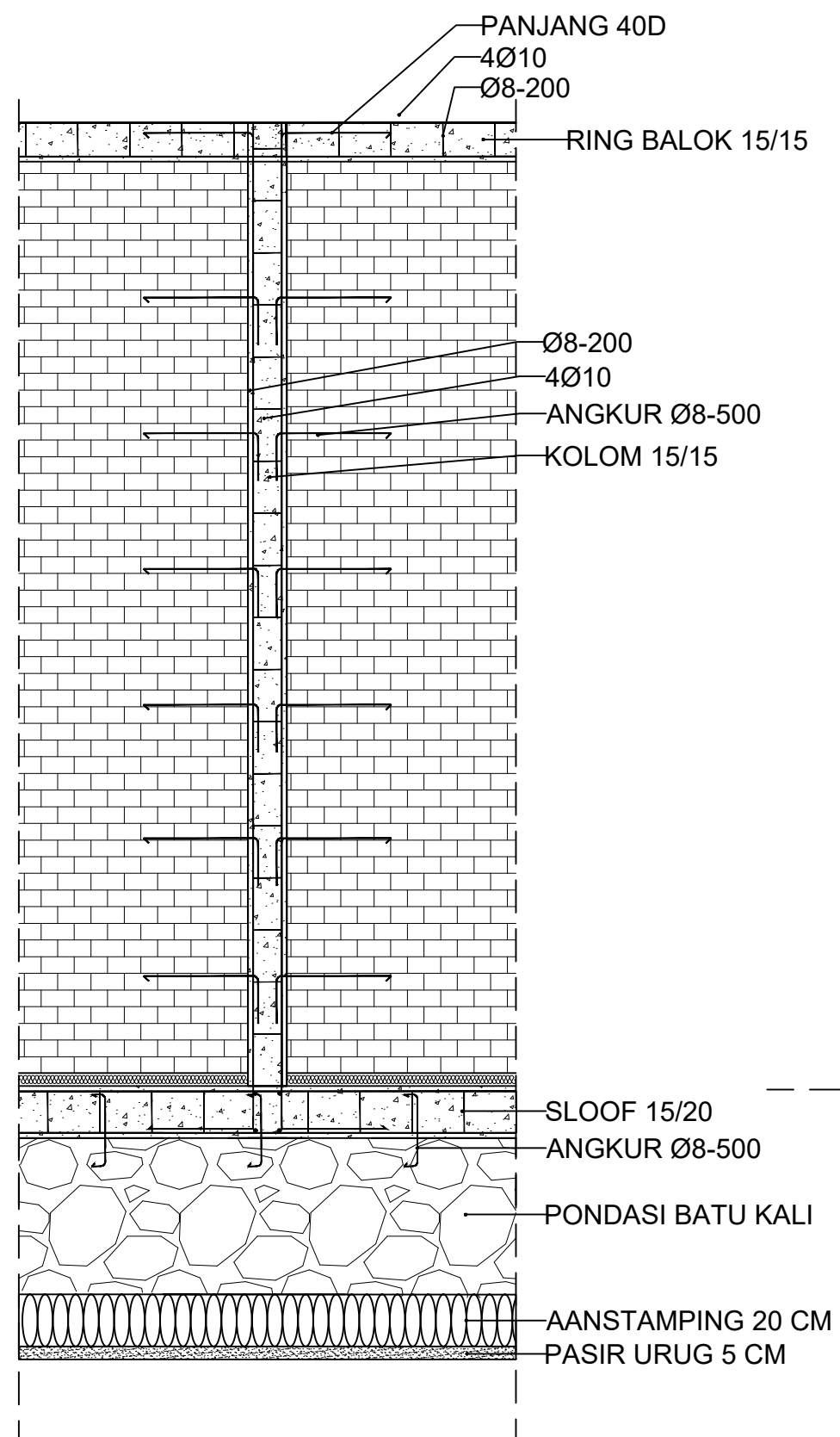

PEMBESIAN PONDASI SLOOF KOLOM & BALOK
SKALA ; 1 : 25

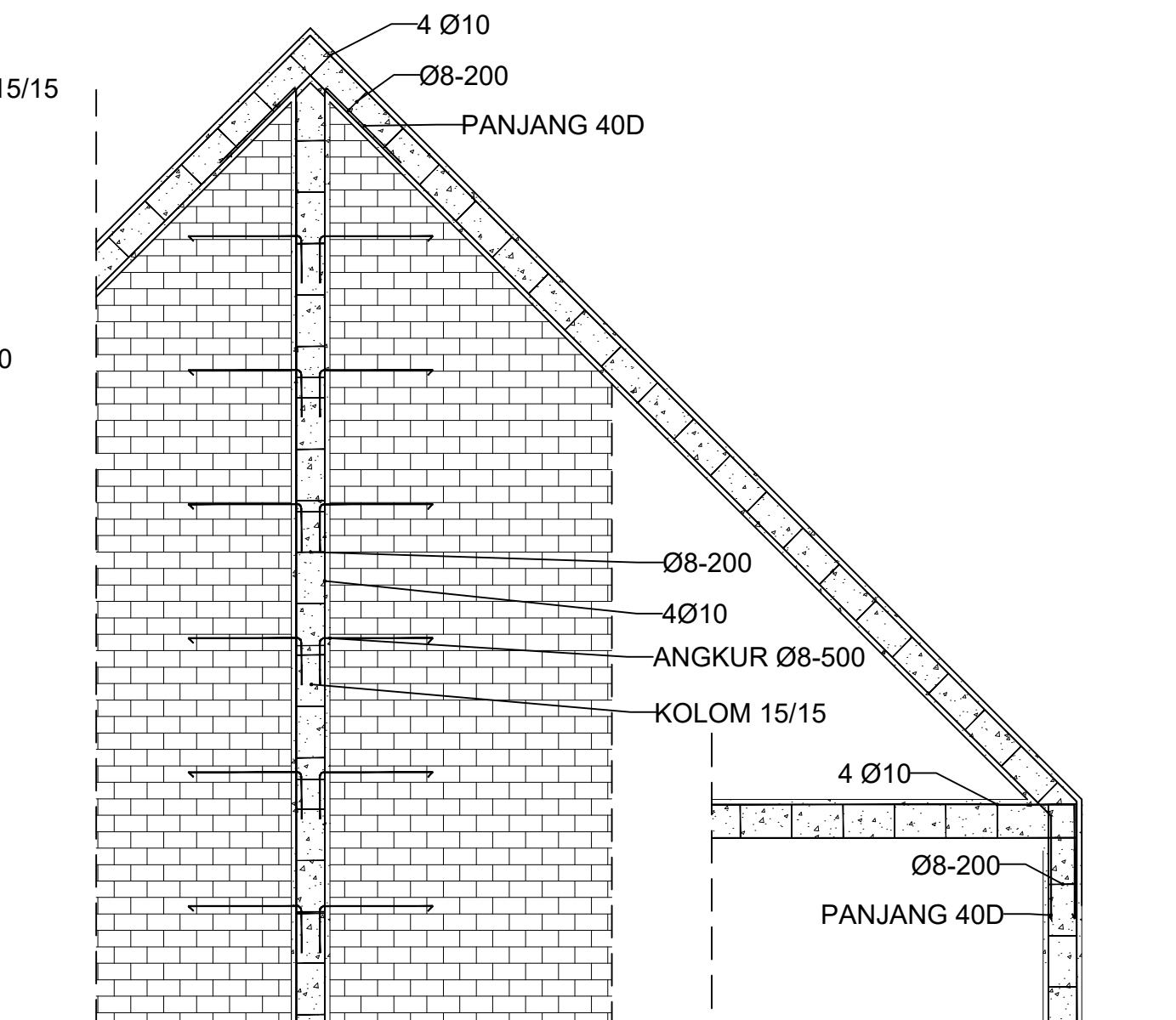

PEMBESIAN BALOK GEWEL
SKALA ; 1 : 25

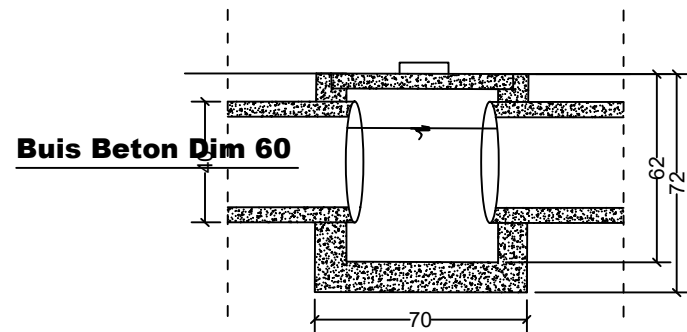

BAK KONTROL DRAINASE

SKALA ; 1:25

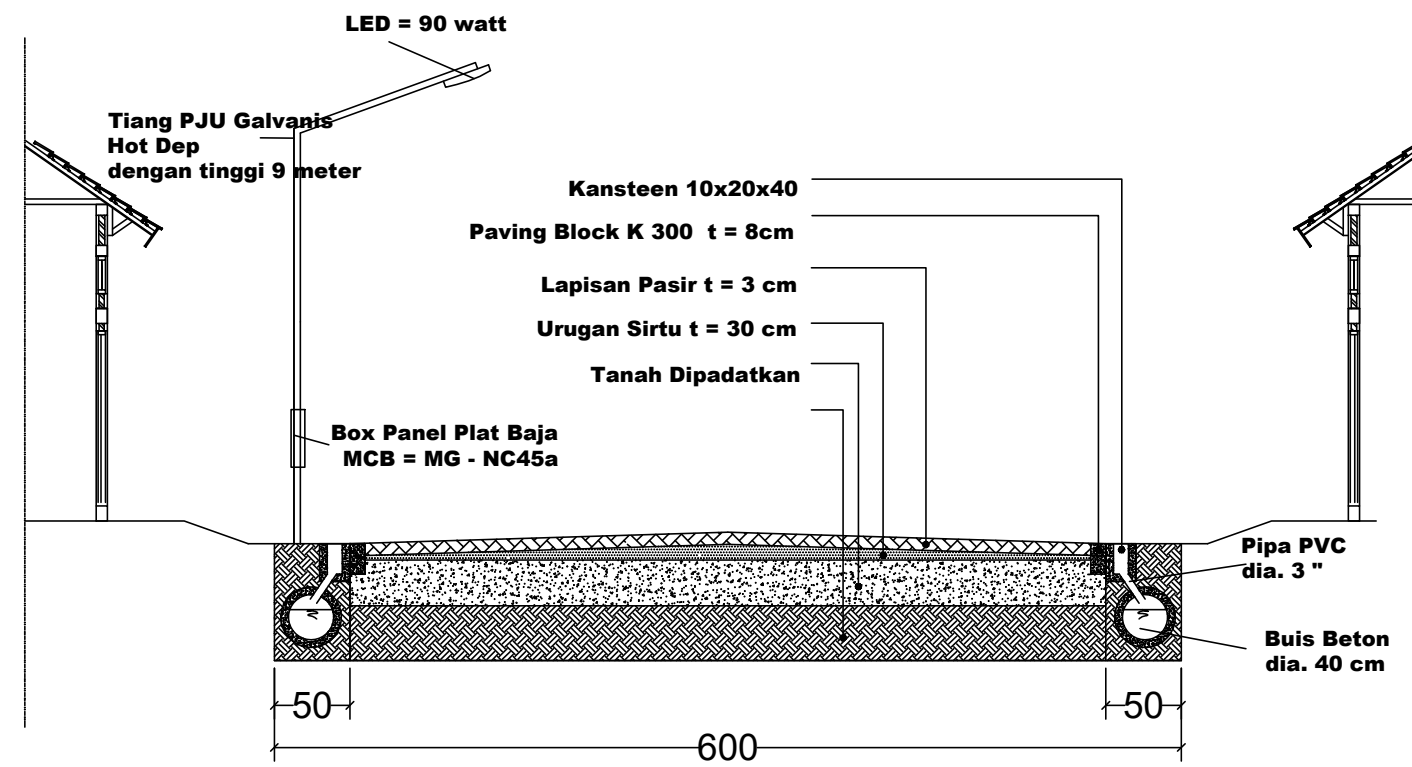

POTONGAN JALAN (ROW 6a)

SKALA ; 1:50

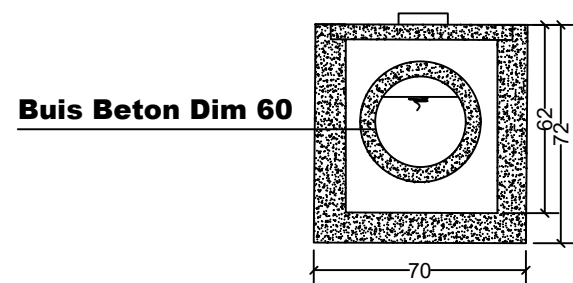

BAK KONTROL DRAINASE

SKALA ; 1:25

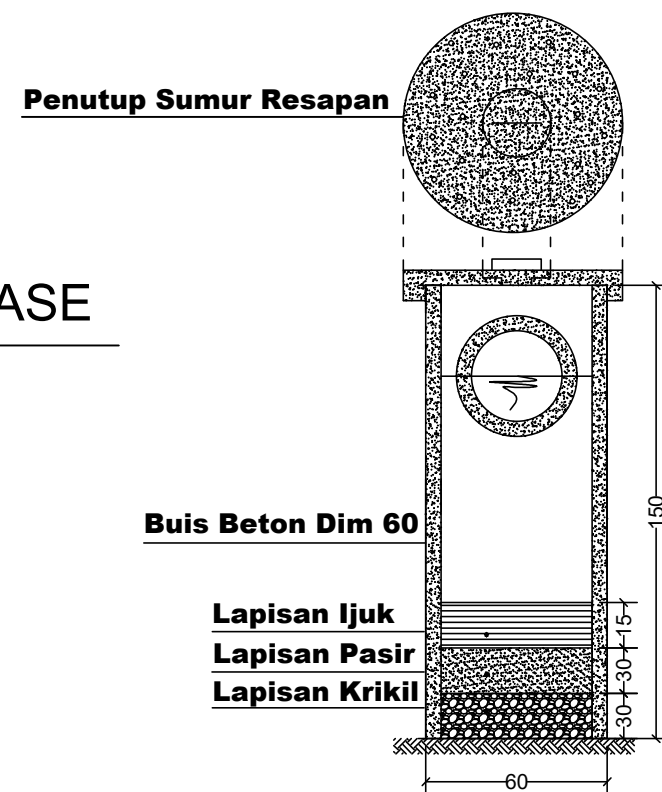

SUMUR RESAPAN

SKALA ; 1:25

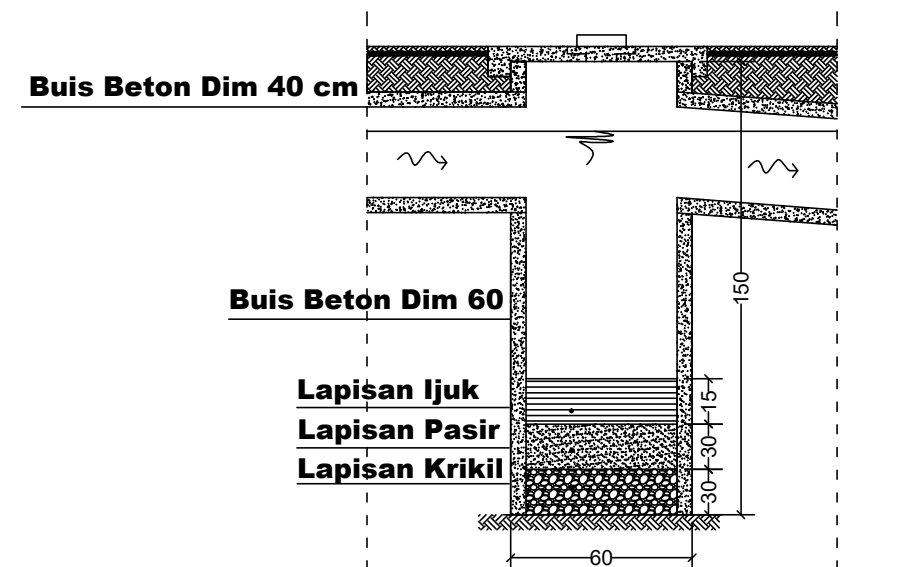

SUMUR RESAPAN

SKALA ; 1:25

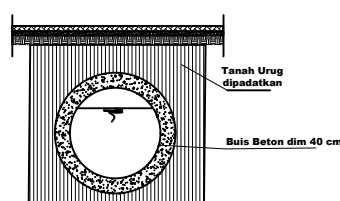

SALURAN DRAINASE

SKALA ; 1:25



DOSEN PEMBIMBING

IR. YUNAN RUSDIANTO., MT
AULIA INDIRA KUMALASARI, ST., MT

NAMA MAHASISWA

AZMI WAHYU IKHSAN
(202110340311133)

RO'YATUL MAULANA S.
(202110340311108)

MOH FATIH ABDURRAHMAN
(202110340311175)

AVICENA HARITZMI A. R.
(202110340311212)

NAMA GAMBAR

PETA KONTUR

SKALA GAMBAR

KETERANGAN

NO. GAMBAR

KERTAS

A3

