



Naskah Publikasi

Suhardi Syafaah Irfan - MPPT Improvement photovolataic solar panel GWO

 Suhardi Syafaah Irfan - MPPT Improvement photovolataic solar panel GWO

 Teknik Elektro

 University of Muhammadiyah Malang

Document Details

Submission ID

trn:oid::1:2996715813

Submission Date

Sep 3, 2024, 12:52 PM GMT+7

Download Date

Sep 3, 2024, 12:55 PM GMT+7

File Name

afaah_Irfan_-_MPPT_Improvement_photovolataic_solar_panel_GWO.pdf

File Size

1.4 MB

12 Pages**3,552 Words****17,230 Characters**

19% Overall Similarity

The combined total of all matches, including overlapping sources, for each database.





Filtered from the Report

- ▶ Bibliography
- ▶ Quoted Text



Exclusions

- ▶ 18 Excluded Matches

Match Groups

-  **7 Not Cited or Quoted 18%**
Matches with neither in-text citation nor quotation marks
-  **0 Missing Quotations 0%**
Matches that are still very similar to source material
-  **0 Missing Citation 0%**
Matches that have quotation marks, but no in-text citation
-  **0 Cited and Quoted 0%**
Matches with in-text citation present, but no quotation marks

Top Sources

- 20%  Internet sources
- 21%  Publications
- 8%  Submitted works (Student Papers)

Integrity Flags

0 Integrity Flags for Review

No suspicious text manipulations found.

Our system's algorithms look deeply at a document for any inconsistencies that would set it apart from a normal submission. If we notice something strange, we flag it for you to review.

A Flag is not necessarily an indicator of a problem. However, we'd recommend you focus your attention there for further review.

Match Groups

- 7 Not Cited or Quoted 18%**
Matches with neither in-text citation nor quotation marks
- 0 Missing Quotations 0%**
Matches that are still very similar to source material
- 0 Missing Citation 0%**
Matches that have quotation marks, but no in-text citation
- 0 Cited and Quoted 0%**
Matches with in-text citation present, but no quotation marks

Top Sources

- 20% Internet sources
- 21% Publications
- 8% Submitted works (Student Papers)

Top Sources

The sources with the highest number of matches within the submission. Overlapping sources will not be displayed.

- 1** **Internet**
eprints.umm.ac.id **11%**
- 2** **Student papers**
Academic Library Consortium **8%**

PAPER • OPEN ACCESS

Improvement of maximum power point tracking (MPPT) efficiency using grey wolf optimization (GWO) algorithm in photovoltaic (PV) system

To cite this article: D Suhardi *et al* 2019 *IOP Conf. Ser.: Mater. Sci. Eng.* **674** 012038

View the [article online](#) for updates and enhancements.

You may also like

- [Dynamic PI-PD cascaded MPPT controller for SPV system with battery charging circuit](#)
Sweety Kumari and Ramesh Kumar
- [Bifurcation and chaos in high-frequency peak current mode Buck converter](#)
Chang-Yuan Chang, , Xin Zhao et al.
- [Trending IC design directions in 2022](#)
Chi-Hang Chan, Lin Cheng, Wei Deng et al.

PRIME
PACIFIC RIM MEETING
ON ELECTROCHEMICAL
AND SOLID STATE SCIENCE

HONOLULU, HI
October 6-11, 2024

Joint International Meeting of
The Electrochemical Society of Japan (ECS)
The Korean Electrochemical Society (KECS)
The Electrochemical Society (ECS)

Early Registration Deadline:
September 3, 2024

MAKE YOUR PLANS NOW!

Improvement of maximum power point tracking (MPPT) efficiency using grey wolf optimization (GWO) algorithm in photovoltaic (PV) system

D Suhardi, L Syafaah, M Irfan, M Yusuf, M Effendy and I Pakaya*

Department of Electrical Engineering, University of Muhammadiyah Malang, Jl. Raya Tlogomas No. 246, Malang 65144, Indonesia

* Email: ilhampakaya@gmail.com

Abstract. Photovoltaics are becoming very popular, because the system does not produce pollution and can be installed anywhere, including in remote areas. However, in the use of photovoltaic found some common problems, it is difficult to get maximum and stable power. Therefore, to overcome these problems using Maximum Power Point Tracking method. On a photovoltaic system it is necessary to determine which converter will be used to increase the power output of the photovoltaic. The design of MPPT using gray wolf optimization algorithm that can track the output power quickly and reduce the oscillation in photovoltaic system. The result of the maximum power tracker using the gray wolf optimization algorithm is better than the incremental conductance algorithm of up to 0,4 s. Converters are used using soft-switching buck converter method to overcome the power losses that often arise in PV systems. The result of power output using soft-switching buck converter is greater than using buck converter. When comparing the efficiency of photovoltaic systems using the gray wolf optimization algorithm increases from using the incremental conductance algorithm.

Keywords: photovoltaic, MPPT, converter, power

1. Introduction

PV has become popular, because this system does not produce pollution and capable installed anywhere, including in remote areas. However, in the use of PV, some common problems are found, such as the difficulty of getting the stable and the maximum power when cloudy conduction or the panels are covered by trees. The power produced by PV depends on light intensity and temperature. Therefore, to overcome the problems which often occur in the PV system, a control system which capable to track the maximum power point of PV is needed, this system is known as the Maximum Power Point Tracker (MPPT).

Several research papers have been published on the developing MPPT algorithm. Jamil's study shows the hill-climbing algorithm works better than conventional algorithms on MPPT systems [1]. However, the output of the system using hill-climbing algorithm has a large noise, so another algorithm that more efficient is developed, such as the Incremental Conductance (IC) algorithm which can increase the power output of the PV compared with the Perturb & Observe (P & O) algorithm [2].

Kumar also proposed the fuzzy algorithm is better than the conventional algorithm, and fuzzy algorithm showed more effective and efficient [3]. Fuzzy algorithm is the basis for the development of new algorithm which inspired by the lives of animals such as Artificial Bee Colony (ABC) which has better Maximum Power Point (MPP) tracking capability on partial shading [4]. The MPPT algorithm functions used to find the maximum power point and maintain at the work point so the desired output



Content from this work may be used under the terms of the [Creative Commons Attribution 3.0 licence](https://creativecommons.org/licenses/by/3.0/). Any further distribution of this work must maintain attribution to the author(s) and the title of the work, journal citation and DOI.

is obtained. The purpose of developing algorithm is to get an MPPT system which should work efficiently, simply and accurately. So Gray Wolf Optimization (GWO) algorithm was made which inspired by the life of a gray wolf.

In PV system other than the determination of the algorithm used, it should also be noted the converter will be used, namely the DC-DC converter which has several basic circuits such as buck converter, boost converter, buck-boost converter, cuck converter and SEPIC converter. DC-DC converter serves to convert direct current into another direct current whose output value could be lower or greater than the input current. The growing development of existing technologies has emerged several novel buck type converter designs, such as soft-switching DC-DC converters which could improve the efficiency of MPPT [5]. Soft-switching is a switching method which functions to store temporary the input energy and release it to the output so increase the efficiency in the system.

2. Method

2.1. Photovoltaic design

The system used in this study uses PV ADT24200. In general, the design of this system is obtained from the equations based on the characteristics of the PV (Figure 1). The replacement circuit and the characteristics of the PV are shown in Fig. 1 and Table 1, respectively.

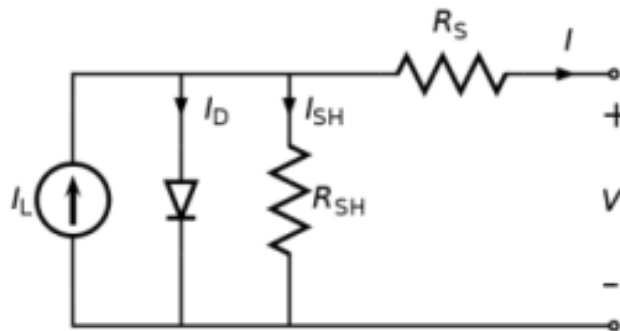

Figure 1. Replacement circuit of photovoltaic

Table 1. Characteristics of PV ADT24200

Characteristics	Amount	Unit
Maximum Power (Pmax)	200	W
Maximum Power Voltage (Vmp)	35	V
Maximum Power Current (Imp)	5,71	A
Open Circuit (Voc)	43	V
Short Circuit Current (Isc)	6,11	A
Jumlah Sell	25	Cel

From the reference and mathematical modelling parameters found in Table 1, the equation 1-5 is obtained [6]:

$$I_{pv} = I_{ph} + I_R \tag{1}$$

$$I_{ph} = (I_{sc} + K_i(T_k - T_{ref})) \frac{G}{G_{ref}} \tag{2}$$

$$I_{rs} = \left(\frac{I_{SCR}}{\left[\exp\left(\frac{qV_{oc}}{N_s K A T}\right) - 1 \right]} \right) \tag{3}$$

$$I_s = I_{rs} \left(\frac{T_c}{T_{ref}} \right)^3 \left[\exp\left(\frac{qE_g \left(\frac{1}{T_{ref}} - \frac{1}{T_k} \right)}{K A}\right) \right] \tag{4}$$

$$I = N_p I_o \left[\exp\left(\frac{q(v_{pv} + I_{pv} R_s)}{N_s A K T}\right) - 1 \right] - V + \frac{I R_s}{R_{sh}} \tag{5}$$

2.2 Converter Design

DC-DC converter has many forms according to their respective functions, each converter has advantages and disadvantages. In this study, the converter used is soft-switching buck converter which used to reduce the voltage and the resulting power losses are less than the usual buck converter [7]. Determination of components in the soft-switching buck converter is the same as determining the value of the components in the buck converter which distinguishes only the soft switching. By determining the parameters to be used, it can perform calculations using equations 6-7 as follows:

$$D = \frac{V_{out}}{V_{in}} \tag{6}$$

$$L = \frac{V_{out}(V_{in} - V_{out})}{\Delta I \times f \times V_{in}} \tag{7}$$

$$C = \frac{\Delta I}{8 \times \Delta V \times f} \tag{8}$$

In terms 6-8 it is shown the calculation of the value of the components to be used, as desired. The values of each component can be determined according to the parameters in table 2 as follows:

Table 2. Data concept on PV parameters

Characteristics	Amount
Power	200 W
Voltage Input	43 V
Voltage Output	34 V
Frequency	10 kHz
Forward Voltage	0. V
Current Output	5,7 A
R	6 Ohm

2.3 MPPT Design

MPPT serves to find maximum power and keep the power produced always at maximum and stable. There are several algorithms used and developed in the MPPT method. Efficient algorithms are needed, fast-tracking and resulting oscillations are more stable [8].

Gray Wolf Optimization (GWO) is one of the new algorithms developed to improve fast-tracking efficiency and the resulting oscillation is more stable. This algorithm is inspired by grey wolves to attack prey for hunting purposes [9]. The negligible value is the best position, in terms of tracking prey. In applying GWO to track maximum power [9]. Figure 2 shows the GWO suitability flowchart when tracking maximum power.

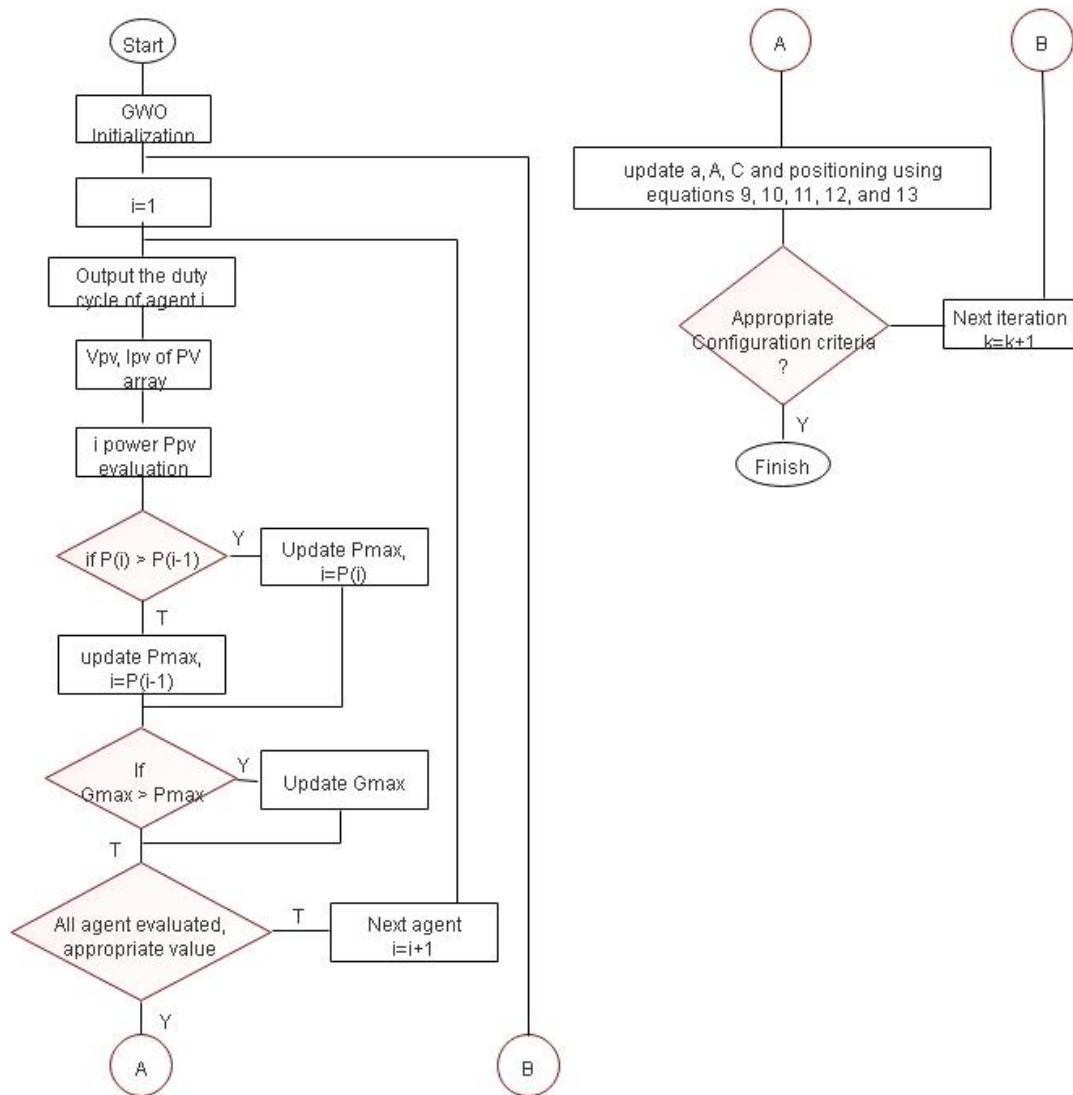

Figure 2. Flowchart of Grey Wolf Optimization (GWO)

In determining the value of the best position in tracking the maximum point of power in a photovoltaic system can be shown in equations 9-10.

$$\bar{D} = |\bar{C} \cdot \bar{X}_p(t) - \bar{X}(t)| \tag{9}$$

$$\bar{X}(t+1) = \bar{X}_p(t) - \bar{A} \cdot \bar{D} \tag{10}$$

Where t is the repetition of the current, D, A, and C represent the coefficient of vector, Xp is the position vector of the prey, and X shows the position vector of the gray wolf. Vector A and C are calculated using equations 11-12 as follows:

$$\bar{A} = 2\bar{a} \cdot \bar{r}_1 - \bar{a} \tag{11}$$

$$\bar{C} = 2 \cdot \bar{r}_2 \tag{12}$$

Where the a component decreases linearly from 2 to 0 during the loop time and r1, r2 is a random vector in [0,1].

In GWO method on MPP, the duty cycle is continued at a constant value. The output value using the GWO oscillation algorithm is reduced rather than using conventional algorithms, reduced power loss and results higher efficiency. To implement MPPT based on GWO, the duty cycle that is considered as a gray wolf. Therefore, it can be changed into equation 13 as follows:

$$D_i(k+1) = D_i(k) - A \cdot D \tag{13}$$

3. Results and Discussion

The results of the simulation of the system have been made and tested to find out the system has been desired. Testing is divided into 3 stages, which are carried out separately.

3.1. Analysis of Photovoltaic

In the first test, the input of the intensity of the sun and temperature is set under normal conditions, so that the I - V and P - V curves can be shown in Figure 3.

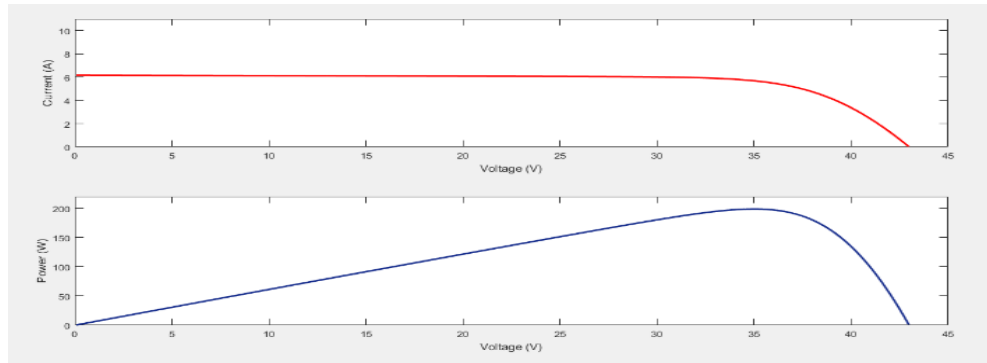

Figure 3. I-V and P-V curves at 25 ° C and light intensity of 1000 W / m2

Figure 3 shows when using a temperature parameter of 25 ° C and Light Intensity of 1000 W / m2, the power reaches 200 Watts at a voltage of 35 V and currents 6 - 6.2 A.

At the second test, the input of the intensity of the sun is set to change and the temperature is set at 25 ° C, so that the P-V curve can be shown in Figure 4.

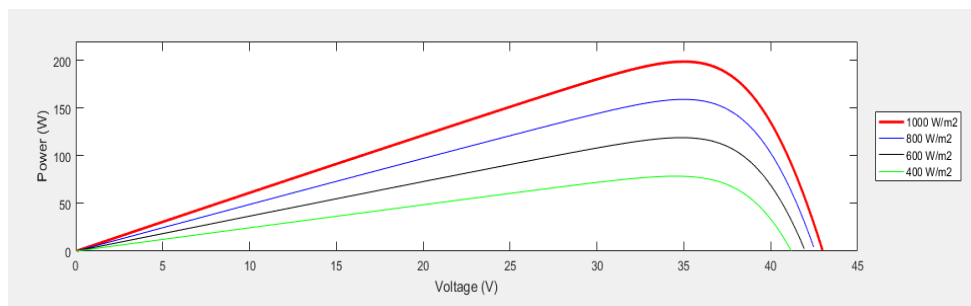

Figure 4. P-V curves at a temperature of 25 ° C and the intensity of light changing

Figure 4 shows the results of the test, if the light intensity received is greater then the power produced is also large. Because the resulting current is getting bigger.

In the third test, the input intensity of the sun is set at 1000W / m2 and the sun's temperature is in changing conditions so that the P-V curve can be shown in Figure 5.

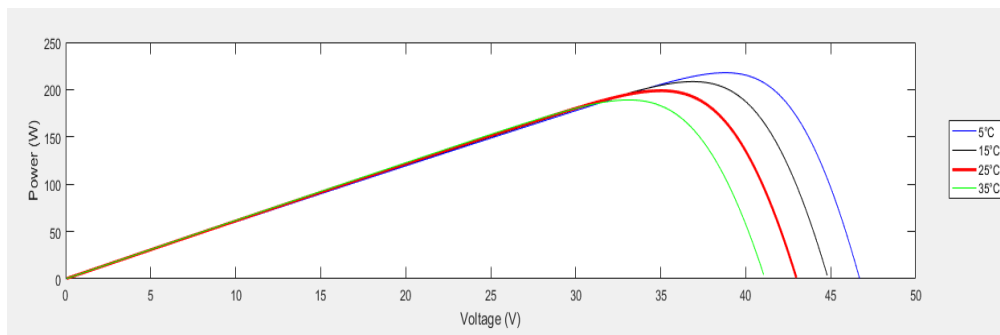

Figure 5. P-V curve at a light intensity of 1000 W / m2 and temperature change

Figure 5 can be analyzed that the test results show that if the temperature received is getting smaller, the resulting power increases, this is inversely proportional to the intensity of light. This test are shown in tables 3 and 4.

Table 3. The maximum difference in power produced by PV at changing light intensity and temperature 25 ° C

Light intensity	Temperature	Current (A)	Voltage (V)	Power (W)
1000 W/m ²	25°C	6 – 6,2	35	200
800 W/m ²		4,5 – 5	35	150 - 180
600 W/m ²		3,2 – 4	35	100 - 120
400 W/m ²		2 – 3	35	60 – 80

Table 4 The maximum power difference produced by PV at a light intensity of 1000 W / m2 and temperature that changes

Temperature	Light intensity	Current (A)	Voltage (V)	Power (W)
5°C	1000 W/m ²	6 – 6,1	41 – 42	240 – 242
15°C		6 – 6,1	39 – 40	224 - 226
25°C		6,1 – 6,2	35	200
35°C		6,1 – 6,2	34	188 – 190

The next test is conditioned when partial shading, so that the I - V and P - V curves can be shown in Figure 6.

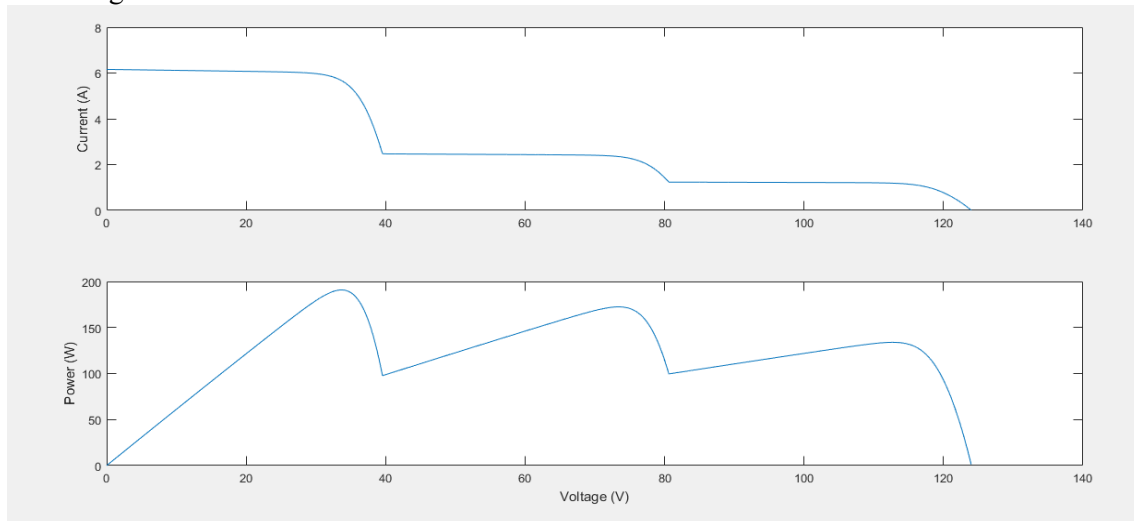

Figure 6. I-V and P-V curves in partial shading conditions

Figure 6 the condition made using 3 panels arranged in series, but the intensity of sunlight is arranged differently from panel 1 to panel 3: 1000 W/m², 400 W/m², 200 W/m². The first test produces a current of 6A and a voltage of 30-40 V produces a maximum power of 200 W. In the second test, the intensity of sunlight received is only 800 W/m² causing a decrease in electric current. Electric current produced is 4.5 - 5 A, the voltage is 30-40 V, and the maximum power is 150 -180 W. In the last test, the intensity of light decreases, the electric current becomes 2 - 3 A, voltage 30 - 40 V, and maximum power 60 - 80 W.

3.2. Test of Converter

In testing the converter can be seen in Figure 7.

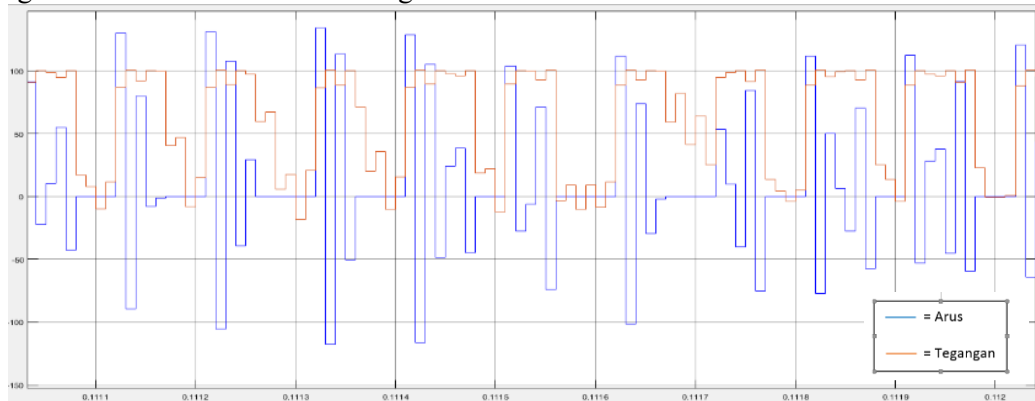

Figure 7. Output Current and Voltage on MOSFET Using Buck Switch Soft Switching.

The converter experiment uses an input voltage of 100V with a duty cycle of 50%, so that the expected output is 50% of input. In Figure 7 shows there is no overlap between current and voltage so that the power produced is greater when using a normal buck converter. In Table 5 below, it will show the output value of each converter which is carried out for 3 s.

Table 5 Soft Switching Comparison Simulation Results Buck Converter and Buck Converter

Converter	Vin (V)	D(%)	Iout (A)	Vout (V)	P (W)
Soft Switching Buck Converter	100	50	8,609	50,64	431,6
Buck Converter	100	50	8,32	50,01	416,24

3.3 Test of MPPT

In the first test, each MPPT was connected to PV and the converter used. The power generated can be seen in Figure 8 and 9.

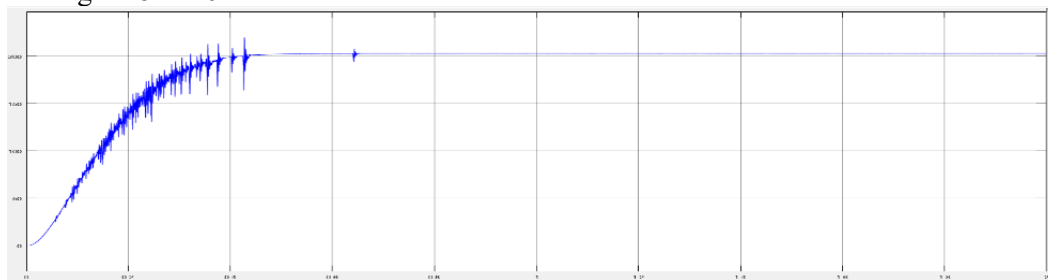

Figure 8. Power Output Using MPPT GWO to Temperature 25 ° C and Light Intensity 1000 W / m2

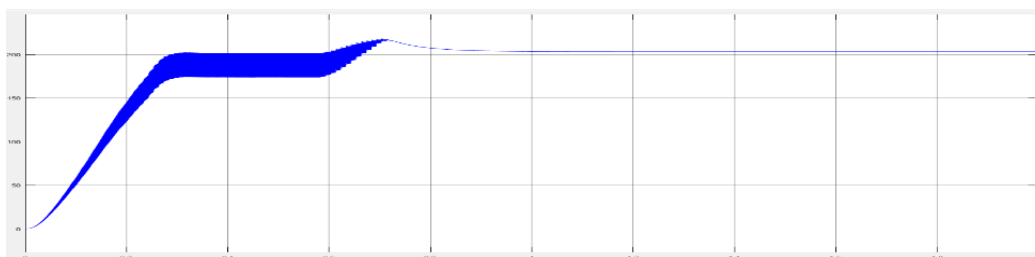

Figure 9. Output Power Using MPPT IC to Temperature 25 ° C and Light Intensity 1000 W / m2

Figures 8 and 9 show the results of testing for Photovoltaics using MPPT using GWO and IC algorithms. During the trial the light intensity is set to 1000 W / m2 and Temperature 25 ° C. It can be seen that the maximum power of the GWO is faster tracking that is 0.44 and the oscillation caused is more stable, so that the power produced is greater than the MPPT using IC requires 0.68 s to reach maximum power. if the maximum power track is faster then the power produced is longer and efficiency increases. The comparison of the resulting power is shown in table 6.

Table 6. Comparison of Power Generated at 25 ° C and light intensity of 1000 W / m2

<i>Algorithm</i>	Power	Efficiency	<i>Tracking</i>
<i>GWO algorithm</i>	203.6 W	0.98 %	0.55 s
<i>IC algorithm</i>	202.2 W	0.97 %	0.95 s

In the second test, each MPPT was connected to PV and the converter used. but in changing light intensity conditions, the power produced can be seen in Figures 10 and 11.

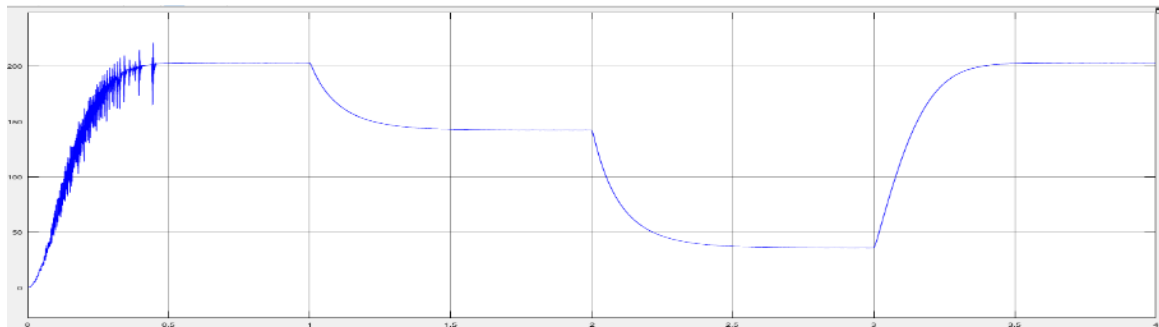

Figure 10. Output Power Using MPPT GWO to 25 ° C Temperature and Changing Light Intensity

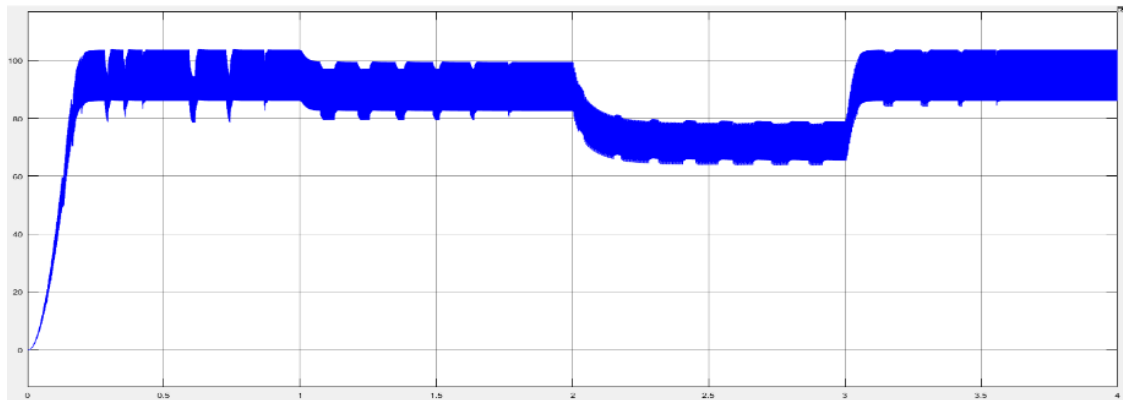

Figure 11. Output Power Using MPPT IC to 25 ° C Temperature and Changing Light Intensity

Figure 10 and 11 of the test results for Photovoltaics using MPPT using GWO and IC algorithms. During the test, the adjustable light intensity changes from 1000 W / m2 - 400 W / m2 decreases every second and at the last second the light intensity is set to increase again to 1000 W / m2, the temperature is set to 25 ° C. It is proven when tracking the maximum power of GWO is faster to track that is 0.55 and the resulting oscillation is more stable, so that the power produced is greater than the MPPT that uses IC. The IC fails to track the maximum power that is caused because the resulting losses are very large. The comparison of the resulting power is shown in table 7.

Table 7 Comparison of Power Generated at 25 ° C and Light Intensity Changed

Algorithm	Light intensity	Maximum power	Efficiency	Tracking
GWO algorithm	1000 W/m ²	203,2 W	98 %	0,55 s
	800 W/m ²	142,2W	98 %	
	400 W/m ²	35,9 W	98 %	
	1000 W/m ²	203,2 W	98 %	
IC algorithm	1000 W/m ²	95,76 W	92 %	-
	800 W/m ²	91,88 W	93 %	
	400 W/m ²	72,86 W	95 %	
	1000 W/m ²	81,92 W	92 %	

In the third test, each MPPT is connected to PV and the converter is used in changing temperature conditions, the power produced can be seen in figures 12 and 13.

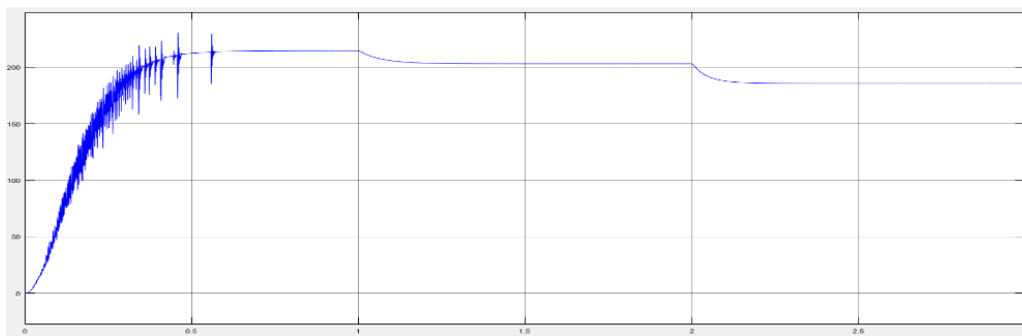

Figure 12. Output Power Using MPPT GWO to Light Intensity of 1000 W / m2 and Changing Temperature

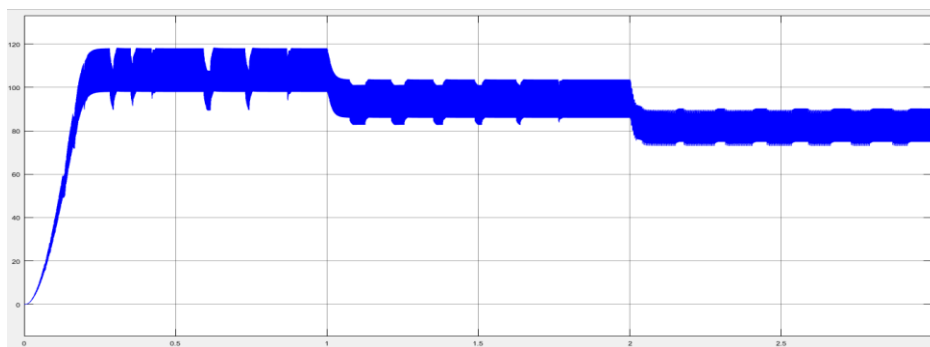

Figure 13. Output Power Using MPPT IC to Light Intensity of 1000 W / m2 and Changing Temperature

Figures 12 and 13 are the results of testing for Photovoltaics using MPPT using GWO and IC algorithms. During the test, the light intensity is set from 1000 W / m2 and the regulated temperature changes from 15 ° C, 25 ° C, 35 ° C every second. From the two results that have been done, it looks

like GWO only takes 0.55 s to track its maximum power, while the IC fails to track its maximum power due to the greater losses. The comparison of the resulting power is shown in table 8.

Table 8 Comparison of Power Generated at Light Intensity of 1000 W / m² and Temperature Changing

Algorithm	Temperature	Maximum power	Efficiency	Tracking
GWO algorithm	15 °C	214,8 W	98 %	0,55 s
	25 °C	203,2 W	98 %	
	35 °C	185,8 W	98 %	
IC algorithm	15 °C	109,1 W	92 %	-
	25 °C	95,76 W	92 %	
	35 °C	83,42 W	92 %	

4. Conclusion

Maximum Power Point Tracker (MPPT) using GWO algorithm is better in tracker compared to MPPT using IC algorithm, GWO tracker time only requires 0.44s. IC requires a longer time of 0.68 s and efficiency increase. Losses are caused when using a DC-DC soft switching buck converter lower than when using a normal DC-DC buck converter, so the output power of the DC-DC soft switching buck converter is greater than the DC-DC buck converter.

References

- [1] I. Jamil, Z. Jinquan, and R. Jamil, "Analysis, Design and Implementation of Zero-Current-Switching Resonant Converter DC-DC Buck Converter," *Int. J. Electr. Electron. Eng. Vol.*, vol. 2, pp. 1–12, 2014.
- [2] M. W. Rahman, C. Bathina, V. Karthikeyan, and R. Prasanth, "Comparative Analysis of Developed Incremental Conductance (IC) and Perturb & Observe (P&O) MPPT Algorithm for Photovoltaic Applications," in *2016 10th International Conference on Intelligent Systems and Control (ISCO)*, 2016, pp. 1–6.
- [3] A. Kumar, P. Chaudhary, and M. Rizwan, "Development of Fuzzy Logic Based MPPT Controller for PV System at Varying Meteorological Parameters," in *2015 Annual IEEE India Conference (INDICON)*, 2015, pp. 1–6.
- [4] P. T. Sawant, P. C. Lbhattar, and C. L. Bhattar, "Enhancement of PV System Based on Artificial Bee Colony Algorithm Under Dynamic Conditions," in *2016 IEEE International Conference on Recent Trends in Electronics, Information & Communication Technology (RTEICT)*, 2016, pp. 1251–1255.
- [5] A. Ambikapathy, G. Singh, and A. Shrivastava, "Efficient Soft-Switching DC-DC Converter for MPPT of a Grid Connected PV System," in *2016 International Conference on Computing, Communication and Automation (ICCCA)*, 2016, pp. 934–938.
- [6] I. W. Christopher and R. Ramesh, "Comparative Study of P&O and InC MPPT Algorithms," *Am. J. Eng. Res.*, vol. 2, no. 12, pp. 402–408, 2013.
- [7] G. C. Diyoke, "Analysis and Simulation of Buck Switch Mode DC to DC Power Regulator," *Int. J. Tech. Res. Appl.*, vol. 3, no. 1, pp. 97–103, 2015.
- [8] S. Mohanty, B. Subudhi, and P. K. Ray, "A Grey Wolf Optimization Based MPPT for PV System Under Changing Insolation Level," in *2016 IEEE Students' Technology Symposium (TechSym)*, 2016, pp. 175–179.
- [9] S. Mohanty, B. Subudhi, and P. K. Ray, "A New MPPT Design Using Grey Wolf Optimization Technique for Photovoltaic System Under Partial Shading Conditions," *IEEE Trans. Sustain. Energy*, vol. 7, no. 1, pp. 181–188, 2015.

Appendix

Nomenclature:

K_i	: Short-circuit current/Temperature Coefficient (0.0017A/K)
K	: Boltzman Constant (1.3805×10^{-23} J/K)
T_{ref}	: Temperature(K)
G	: Intensity
I_{sc}	: Short Circuit Current
I_s	: Saturation Current
T_k	: Actual Temperature (K)
T_{ref}	: Reference Temperature
q	: Electron charge (1.6×10^{-19} C)
E_g	: Bandgap energy ($E_{g0} = 1.1$ eV)
V_{oc}	: Open Circuit Voltage (V)