



## Digital Receipt

This receipt acknowledges that **Turnitin** received your paper. Below you will find the receipt information regarding your submission.

The first page of your submissions is displayed below.

Submission author: Naspub Turnitin  
Assignment title: Artikel Dosen  
Submission title: Buck-boost Converter using GA-based MPPT for Solar Energ...  
File name: Converter\_using\_GA-based\_MPPT\_for\_Solar\_Energy\_Optimiz...  
File size: 685.27K  
Page count: 7  
Word count: 4,313  
Character count: 22,401  
Submission date: 14-Oct-2023 05:19AM (UTC+0700)  
Submission ID: 2195020739

 **Kinetic: Game Technology, Information System, Computer Network, Computing, Electronics, and Control**  
Journal homepage: <http://www.kinetic.us.id>  
ISSN: 2653-2921  
Vol. 8, No. 3, August, Pp. 607-614

 **Buck-boost converter using GA-based MPPT for solar energy optimization** 607

 **Lailis Syafaah<sup>1</sup>, Amrui Faruq<sup>1</sup>, Basri Noor Cahyadi<sup>1</sup>, Khusnul Hidayat<sup>1</sup>, Novendra Setyawan<sup>1</sup>, Merinda Lestandy<sup>1</sup>, Zulfaatman<sup>1</sup>**  
Department of Electrical Engineering, Faculty of Engineering, Universitas Muhammadiyah Malang, Malang, Indonesia<sup>1</sup>

**Article Info**  
**Keywords:** MPPT, Buck Boost Converter, Genetic Algorithm, Photovoltaic, Battery, Poultry Farm  
**Article history:**  
Received: Desember 26, 2022  
Accepted: April 01, 2023  
Published: August 31, 2023

**Cite:**  
L. Syafaah, "Buck-boost Converter using GA-based MPPT for Solar Energy Optimization", KINETIK, vol. 8, no. 3, Aug. 2023, <https://doi.org/10.22219/kinetik.v8i3.1658>

**\*Corresponding author:**  
Lailis Syafaah  
E-mail address:  
[lailis@um.ac.id](mailto:lailis@um.ac.id)

**Abstract**  
Energy optimization in the Solar Power Plant system needs to have more attention. Indonesia is a tropical country that has two seasons, where the weather and cloud movements are frequently unpredictable, especially in the southern region of Java Island. To overcome this problem, an inverter equipped with maximum power point tracking (MPPT) was used. However, the current MPPT switching system was still not optimal with an efficiency of around 90%. In this study, the installation of MPPT was carried out in order to optimize the power in solar photovoltaic (PV) system due to the fluctuations of solar irradiation at PT. Jatim Indah Agri, Blitar City. The maximum power generated by solar photovoltaic could be achieved by using the combination of DC-DC converter and artificial intelligence. In this study, the modeling of solar PV system was made using MATLAB software, where the design of the solar PV system consisted of a PV module with capacity 240W, DC to DC converter, battery and MPPT. Genetic Algorithm (GA)-based MPPT had been tested and compared to Particle Swarm Optimization (PSO)-based MPPT and conventional MPPT, where the GA-based MPPT worked well in finding the maximum power point in the solar photovoltaic system. It was found that GA-based MPPT produced a maximum power point close to PV power with an efficiency of 92%, while the efficiency of PSO-based MPPT and conventional MPPT were 85% and 79% respectively. In selecting the method for designing MPPT, a method with a wide range of sample data is required. This is due to the fluctuation of solar irradiance received by the solar PV.

**1. Introduction**  
PT. Jatim Indah Agri is located in Jatimindah village, Blitar city. In this village, there are many Micro, Small and Medium Enterprises (MSMEs), including vegetable traders, grocery stores, eateries, laying hen breeders, and the like. PT. Jatim Indah Agri is a laying hen breeder company with a close house type of cage which is also the center of the laying hen industry in the surrounding area. The average power usage in a closed chicken coop is 1MMWh/month or the equivalent of IDR 25,000,000-. Therefore, an innovation in the field of PLTS is needed to reduce the amount of energy consumption from PLN. Based on the data from NASA Prediction of Worldwide Energy Resource, Indonesian has quite high solar energy potential of around 3 – 4.6 kWh/m<sup>2</sup>, but the Meteorology, Climatology and Geophysics Agency (BMKG) stated that Blitar city has an Average Rainy Days value of 150mm or a moderate level. In addition, Blitar also often has cloudy conditions, which causes the irradiance intensely received by solar panels is very small and fluctuating, namely around 800 Wh/m<sup>2</sup>.

Solar power plants have been installed at PT. Jatim Indah Agri with a total capacity of 10kWp, but from this installation the average energy generated per day was 42 kWh or there was a decrease by 20% of the total installed power plants. This decrease can be caused by fluctuations in the amount of solar radiation [2]. Currently, the MPPT system used was the conventional MPPT, where the DC-DC converter control system was operated manually. However, this method were unable to produce maximum output. On this matter, an intelligent computing method is needed to produce the maximum power value [3][4]. Controlling the MPPT with an inaccurate method can result in a shift in the PV maximum power point due to changes in lighting and ambient temperature, as well as frequent disturbances which result in certain power losses [5]. Therefore, controlling MPPT using intelligent computing methods will be very useful for optimizing the power and reducing the frequent disturbances so that power quality can be maintained properly and power loss can be minimized [6]. In addition, MPPT installation also requires a DC-DC converter. The DC-DC converter is useful as a voltage level converter either up or down from regulated or unregulated direct current [7].

MPPT design using intelligent computing methods had been widely carried out in previous studies [8][9][10][11][12]. From the results of this study, various maximum power values were obtained. However, the previous

Cite: L. Syafaah, "Buck-boost Converter using GA-based MPPT for Solar Energy Optimization", KINETIK, vol. 8, no. 3, Aug. 2023, <https://doi.org/10.22219/kinetik.v8i3.1658>

# Buck-boost Converter using GA-based MPPT for Solar Energy Optimization

*by Naspub Turnitin*

---

**Submission date:** 14-Oct-2023 05:19AM (UTC+0700)

**Submission ID:** 2195020739

**File name:** Converter\_using\_GA-based\_MPPT\_for\_Solar\_Energy\_Optimization.pdf (685.27K)

**Word count:** 4313

**Character count:** 22401



## Buck-boost converter using GA-based MPPT for solar energy optimization

Lailis Syafaah<sup>\*1</sup>, Amrul Faruq<sup>1</sup>, Basri Noor Cahyadi<sup>1</sup>, Khusnul Hidayat<sup>1</sup>, Novendra Setyawan<sup>1</sup>, Merinda Standy<sup>1</sup>, Zulfatman<sup>1</sup>

Department of Electrical Engineering, Faculty of Engineering, Universitas Muhammadiyah Malang, Malang, Indonesia<sup>1</sup>

### Article Info

#### Keywords:

MPPT, Buck Boost Converter, Genetic Algorithm, Photovoltaic, Battery, Poultry Farm

#### Article history:

Received: December 28, 2022

Accepted: April 01, 2023

Published: August 31, 2023

#### Cite:

L. Syafaah, "Buck-boost Converter using GA-based MPPT for Solar Energy Optimization", KINETIK, vol. 8, no. 3, Aug. 2023.  
<https://doi.org/10.22219/kinetik.v8i3.1658>

<sup>\*</sup>Corresponding author.

Lailis Syafaah

E-mail address:

[lailis@umm.ac.id](mailto:lailis@umm.ac.id)

### Abstract

Energy optimization in the Solar Power Plant system needs to have more attention. Indonesia is a tropical country that has two seasons, where the weather and cloud movements are frequently unpredictable, especially in the southern region of Java Island. To overcome this problem, an inverter equipped with maximum power point tracking (MPPT) was used. However, the current MPPT switching system was still not optimal with an efficiency of around 90%. In this study, the installation of MPPT was carried out in order to optimize the power in solar photovoltaic (PV) system due to the fluctuations of solar irradiation at PT. Jatinom Indah Agri, Blitar City. The maximum power generated by solar photovoltaic could be achieved by using the combination of DC - DC converter and artificial intelligence. In this study, the modeling of solar PV system was made using MATLAB software, where the design of the solar PV system consisted of a PV module with capacity 240W, DC to DC converter, battery and MPPT. Genetic Algorithm (GA)-based MPPT had been tested and compared to Particle Swarm Optimization (PSO)-based MPPT and conventional MPPT, where the GA-based MPPT worked well in finding the maximum power point in the solar photovoltaic system. It was found that GA-based MPPT produced a maximum power point close to PV power with an efficiency of 92%, while the efficiency of PSO-based MPPT and conventional MPPT were 85% and 79% respectively. In selecting the method for designing MPPT, a method with a wide range of sample data is required. This is due to the fluctuation of solar irradiance received by the solar PV.

### 1. Introduction

PT. Jatinom Indah Agri is located in Jatinom village, Blitar city. In this village, there are many Micro, Small and Medium Enterprises (MSMEs), including vegetable traders, grocery stores, eateries, laying hen breeders, and the like. PT. Jatinom Indah Agri is a laying hen breeder company with a close house type of cage which is also the center of the laying hen industry in the surrounding area. The average power usage in a closed chicken coop is 14MWh/month or the equivalent of IDR 25,000,000.-. Therefore, an innovation in the field of PLTS is needed to reduce the amount of energy consumption from PLN. Based on the data from NASA Prediction of Worldwide Energy Resource, Indonesian has quite high solar energy potential of around 3 – 4.6 kWh/m<sup>2</sup>, but the Meteorology, Climatology and Geophysics Agency (BMKG) stated that Blitar city has an Average Rainy Days value of 150mm or a moderate level. In addition, Blitar also often has cloudy conditions, which causes the irradiance intensity received by solar panels is very small and fluctuating, namely around 800 Wh/m<sup>2</sup>.

Solar power plants have been installed at PT. Jatinom Indah Agri with a total capacity of 10kWp, but from this installation the average energy generated per day was 42 kWh or there was a decrease by 20% of the total installed power plants. This decrease can be caused by fluctuations in the amount of solar radiation [2]. Currently, the MPPT system used was the conventional MPPT, where the DC-DC converter control system was operated manually. However, this method were unable to produce maximum output. On this matter, an intelligent computing method is needed to produce the maximum power value [3][4]. Controlling the MPPT with an inaccurate method can result in a shift in the PV maximum power point due to changes in lighting and ambient temperature, as well as frequent disturbances which result in certain power losses [5]. Therefore, controlling MPPT using intelligent computing methods will be very useful for optimizing the power and reducing the frequent disturbances so that power quality can be maintained properly and power loss can be minimized [6]. In addition, MPPT installation also requires a DC-DC converter. The DC-DC converter is useful as a voltage level converter either up or down from regulated or unregulated direct current [7].

MPPT design using intelligent computing methods had been widely carried out in previous studies [8][9][10][11][12]. From the results of this study, various maximum power values were obtained. However, the previous

research methods still had some drawbacks. These methods still had various deficiencies in their tracking performance and the output power was still not optimal. Hence, the desired result was not fulfilled. Therefore, it is necessary to carry out further research using other intelligent computing methods [13]. In a research journal, an MPPT installation design was carried out on a PV system with a maximum power specification of 200 W. After an optimization with MPPT using Particle Swarm Optimization (PSO) method at a constant irradiation of  $1000 \text{ W/m}^2$  and a temperature of  $25^\circ\text{C}$ , an output power of 182, 84 W at a voltage of 30.98 V and a current of 5.9 A, where the efficiency obtained was 91.42%. The time required to reach the maximum power was 0.4 seconds [14] [15].

From the previous studies, PSO-based MPPT design was good enough to use as it could produce almost maximum power. However, this method was not optimal if there was a large voltage drop because the PSO method could not search a wider solution space. To cover these deficiencies, this study proposed the design of MPPT based on the Genetic Algorithm (GA) method and adding a battery on DC bus. In addition, the DC-DC converter applied in the MPPT was a buck boost converter, where this system had high performance and was able to adapt quickly to changes in voltage [16]. With the addition of battery, the PV system could store excess power which later could be used to supply power shortages to the load.

## 2. Research Method

Figure 1 shows the proposed research flow, where in this study the MATLAB software was used to design MPPT and Simulation.

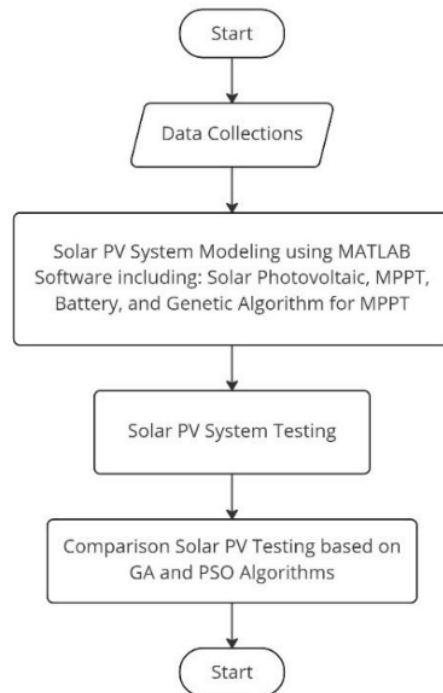

Figure 1. The research flowchart

Referring to Figure 1, this study was started by collecting data from the website global solar atlas including irradiation and temperature at PT. Jatinom Indah Agri area. After obtaining the parameter data, the modeling systems were carried out on Simulink MATLAB including photovoltaic module, MPPT, DC-DC converter, and Genetic Algorithm. When all the modeling had been completed, the entire PV mini-grid system was tested. The last step was to analyze the results and draw conclusions from the work of the PLTS system that had been made.

### 2.1 Block Diagram System

The design of the system used in this study was illustrated by Figure 2, where this system was built from three main components, namely solar photovoltaic, DC-DC converter and GA-based MPPT.

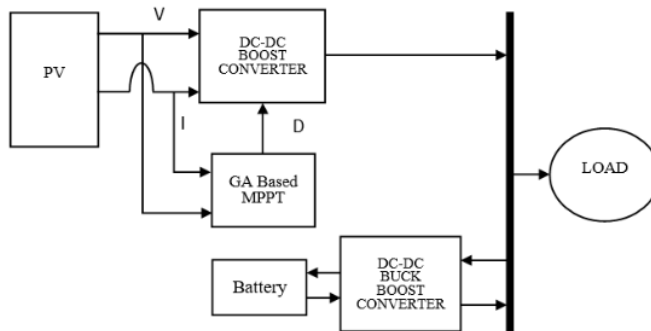

Figure 2. Block diagram of solar system

## 2.2 Photovoltaic Module

A solar cell is basically a p-n semiconductor junction which directly converts light energy into electricity by virtue of the photoelectric effect. PV cells grouped in larger units form a PV module and the interconnection of more PV modules in a series parallel configuration forms a PV array. The PV equivalent circuit was shown in Figure 3.

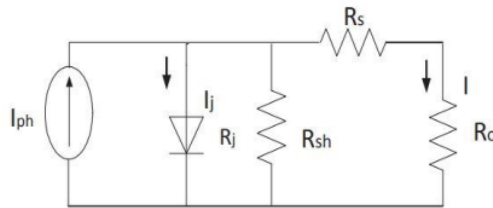

Figure 3. Series of solar cell equations

From Figure 3  $I_{ph}$  is the photocurrent of the cell,  $R_j$  is the (non-linear) impedance of the p-n junction and  $R_{sh}$  and  $R_s$  are the resistance and series of the cell, respectively. Usually, the  $R_{sh}$  value is very large and the  $R_s$  value is very small, so it can be ignored to simplify the analysis [17].

## 2.3 DC-DC Converter

### 2.3.1 Boost Converter

DC-DC boost converter is a converter that is used to increase the voltage. With the help of this converter, which was originally a low-level voltage can be increased to a higher-level output voltage [19], [20]. The DC-DC boost converter circuit is shown in Figure 4.

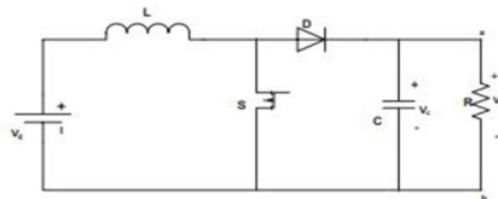

Figure 4. DC-DC boost converter circuits

The DC-DC boost converter circuit worked when switch  $S_1$  was turned on by Pulse Width Modulation (PWM), current flowed through the inductor ( $L$ ) and energy was stored in it. When the switch was turned off, energy stored in the inductor in the form of a magnetic field provided an induced voltage across the inductor which added to the input voltage. The input voltage and the voltage across the inductor were in series and collectively charge the output capacitor ( $C_{out}$ ) to a higher voltage than the input voltage [21].

When designing a conventional boost converter, according to the required output voltage, the working system could be calculated by Equation 1.

$$D = 1 - \frac{V_o}{V_i} \quad (1)$$

For inductor selection, the inductor value was selected based on the estimated inductor ripple current at maximum input voltage, given by Equation 2.

$$L = \frac{V_o (V_i - V_o)}{\Delta I L \cdot f_s \cdot V_o} \quad (2)$$

$\Delta I L$  is the approximate inductor ripple current. For continuous conduction mode, the minimum inductance required is  $L_c$  as presented in Equation 3.

$$L_c = \frac{D(1-D)^2 R_o}{2 \cdot f_s} \quad (3)$$

For the selection of capacitors, the value of the capacitor was calculated by varying the output voltage or ripple as in Equation 4.

$$C = \frac{D}{R_o \cdot f_s \left( \frac{\Delta V_o}{V_o} \right)} \quad (4)$$

$\Delta V_o$  is the desired output voltage ripple, for a voltage ripple of 1% according to the output voltage of Equation 5 it becomes:

$$C = \frac{D}{R_o \cdot f_s \cdot 0.01} \quad (5)$$

### 2.3.2 Bidirectional Buck Boost Converter

DC-DC buck boost converter is a converter with the function of increasing or decreasing the input voltage. The output voltage generated by the buck-boost converter can be below or above the source voltage. Generally, the working principle of switching on the buck boost converter is similar to the boost converter, where the output power is regulated by controlling the MOSFET gate [22]–[24]. The DC-DC buck boost converter circuit is shown in Figure 5.

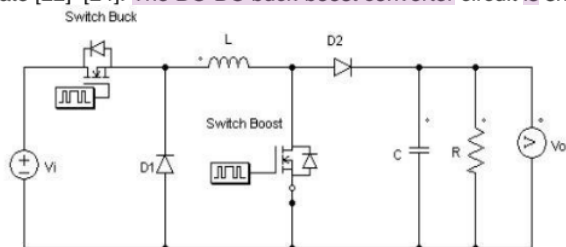

Figure 5. DC-DC buck boost converter

### 2.4 Genetic Algorithm (GA)

Genetic Algorithm (GA) is an adaptive algorithm that can be used to find a large space for optimization. This algorithm works on the principle of survival of the fittest using natural biological selection [26]. A large number of samples called individuals represent possible solutions to the problem. Reproduction was carried out between the most suitable individuals by means of a cross-breeding process, the selection process is carried out and the unfavorable individuals were eliminated. The new generation, known as off-springs, had several features transferred from each individual parent. The new population of possible solutions was selected by mating the best individuals containing the characteristics of the matched members of the previous generation. In this way good qualities are passed from one generation to another until all individuals possessing the same good qualities meet each other. Facilitating the mating

of the strongest individuals helped in exploring the most optimal areas in the search space, so that the optimal solution of a problem could be achieved [27][28][29].

### 3. Results and Discussion

This section explains the results of testing the proposed system which comparing DC-DC converter using GA-based MPPT to conventional MPPT and PSO-based MPPT.

#### 3.1 DC-DC converter with GA-based MPPT

This test was carried out in order to know the efficiency of the DC-DC converter with GA-based MPPT. This test used a solar PV system with a capacity of 240 Wp, which was given a different number of irradiations i.e. (1000W/m<sup>2</sup>, 644W/m<sup>2</sup>, 543W/m<sup>2</sup>, 426W/m<sup>2</sup>). Table 1 shows the result from the DC-DC converter with GA-based MPPT, where the average efficiency value of the system is 97%. In addition, the test results also show that the proposed MPPT system was able to maintain efficiency even though there was a decrease in irradiation. This condition was shown when solar irradiation hit the lowest value (426 Wh/m<sup>2</sup>) the MPPT system was able to maintain an efficiency value of 96.38%.

Table 1. The result of DC-DC converter with GA-based MPPT

Irradiation (Wh/m <sup>2</sup> )	Voltage (V)		Current (A)		Power (W)		Efficiency (%)
	PV	MPPT	PV	MPPT	PV	MPPT	
1000	31	48	6.9	4.36	214	209.2	97.76
644	24.1	36.5	5.16	3,3	124.3	120.45	96.90
543	20.4	30.8	4.37	2.8	89.1	86.42	96.99
426	16.1	24.2	3.43	2.2	55.3	53.3	96.38

#### 3.2 The Comparison between Conventional MPPT and GA-based MPPT

This test was carried out in order to know the performance of proposed MPPT system. Figure 6 shows the performance of power generated by the proposed MPPT, solar PV, and Conventional MPPT. The results show that the GA-based MPPT has good performance, where the power generated by the system closed to the power generated by the solar PV. Whereas conventional MPPT produced much lower power than GA-based MPPT, with an efficiency value of 79% at 1000 Wh/m<sup>2</sup> irradiation and 55% at 426 Wh/m<sup>2</sup> irradiation.

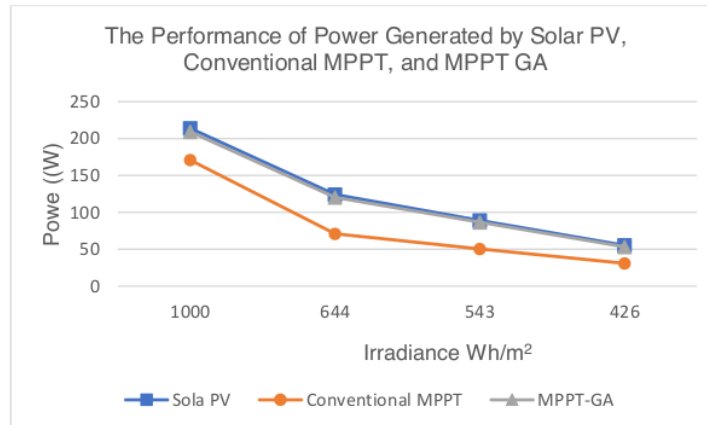

Figure 6. The performance of power generated by solar PV, conventional MPPT, and GA-based MPPT solar irradiance

DC-DC converter with GA-based MPPT has better efficiency than the conventional MPPT, this is due to the optimal switching system. In the GA-based MPPT, the voltage and current samples at the solar PV output were accommodated and used as reference data. These data were used to determine the magnitude of the PWM value in the switching system. So that the output on the DC-DC converter was more optimal compared to the conventional method, where in the conventional method the PWM value was determined manually by determining the set point value. In addition, GA-based MPPT could adapt well when there was a decrease in power on the solar panel.

### 3.3 The Comparison between GA-based MPPT and PSO-based MPPT

This test was carried out to find out the performance of GA-based MPPT and PSO-based MPPT. Tests were carried out using solar panels with a capacity of 240 Wp which were given varying irradiation values i.e. 1000W/m<sup>2</sup>, 644W/m<sup>2</sup>, 543W/m<sup>2</sup>, 426W/m<sup>2</sup>.

Figure 7 shows the MPPT output power under different irradiation conditions. The proposed GA-based MPPT has better performance compared to PSO-based MPPT with an average efficiency of 92%. The power generated by GA-based MPPT was always close to the maximum power point of solar PV even though there was a decrease in irradiation value. This proves that the set point values generated from the GA method could adapt better to any environmental condition compared to the PSO method.

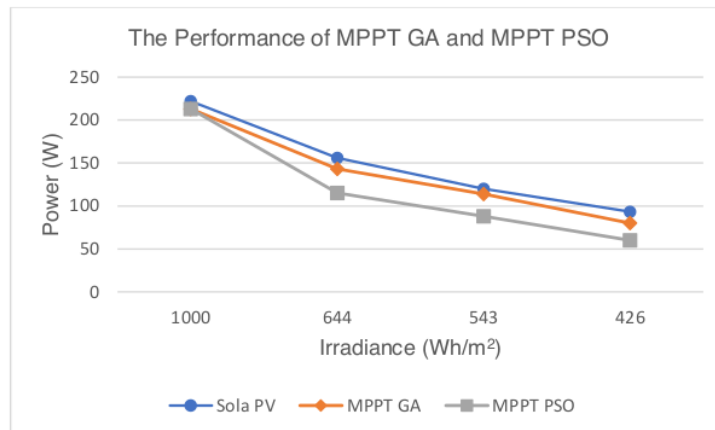

Figure 7. The performance of power generated by GA-based MPPT and PSO-based MPPT

## 4. Conclusion

The main objective of this research was to design a genetic algorithm-based MPPT to optimize the power of solar photovoltaic system at PT. Jatinom Indah Agri. In this study, there were three proposed MPPT designs i.e. GA-based MPPT, PSO-based MPPT, and conventional MPPT. From the systems testing, it was found that GA-based MPPT produced a maximum power point close to PV power with an efficiency of 92%, while PSO-MPPT and conventional MPPT had an efficiency of 85% and 79% respectively. GA-based MPPT was able to adapt better compared to PSO-based MPPT. This can be seen in system testing by giving different irradiation values. When the irradiation value was 1000 Wh/m<sup>2</sup> the efficiency of the GA-based MPPT was 95% and the efficiency of PSO-based MPPT was 95%. However, when the irradiation value was 644 Wh/m<sup>2</sup> the efficiency of GA-based MPPT was 91% and the efficiency of PSO-based MPPT fell by 75%. In selecting the method for designing MPPT, a method with a wide range of sample data is required. This is due to the fluctuating characteristics of the irradiation value received by solar PV.

### Notation

$D$	: Duty cycle
$L$	: Inductors
$C$	: Capacitors
$L_c$	: Minimum inductance

### Acknowledgements

Thanks to the Directorate General of Higher Education, Research and Technology and Ministry of Education, Culture, Research and Technology Indonesia for supporting this research through the Matching Fund program 2022. Hopefully, this research can make a major contribution to the advancement of technology in Indonesia.

### References

- [1] M.R. Javed *et al.*, "A comparative study of maximum power point tracking techniques for solar systems," *Proc. - 22nd Int. Multitopic Conf. INMIC 2019*, Nov. 2019. <https://doi.org/10.1109/INMIC48123.2019.9022762>
- [2] M. Ben Smida and A. Sakly, "Genetic based algorithm for maximum power point tracking (MPPT) for grid connected PV systems operating under partial shaded conditions," *Proc. 2015 7th Int. Conf. Model. Identif. Control. ICMIC 2015*, Feb. 2016. <https://doi.org/10.1109/ICMIC.2015.7409433>

© 2023 The Authors. Published by Universitas Muhammadiyah Malang

This is an open access article under the CC BY NC SA license (<https://creativecommons.org/licenses/by-nc-sa/4.0/>)



- [3] M. Nour Ali, "Improved Design of Artificial Neural Network for MPPT of Grid-Connected PV Systems," *2018 20th Int. Middle East Power Syst. Conf. MEPCON 2018 - Proc.*, pp. 97–102, Feb. 2019. <https://doi.org/10.1109/MEPCON.2018.8635202>
- [4] N.M. Elbehairy, R.A. Swief, A.M. Abdin, and T. S. Abdelsalam, "Maximum Power Point Tracking for a Stand Alone PV System under Shading Conditions Using Flower Pollination Algorithm," *2019 21st Int. Middle East Power Syst. Conf. MEPCON 2019 - Proc.*, pp. 840–845, Dec. 2019. <https://doi.org/10.1109/MEPCON47431.2019.9008230>
- [5] X. Meng, Y. An, H. Wang, Q. Yao, and C. Liang, "Tracking the Maximum Power Point of Photovoltaic Power Generation Based on Self-coding Neural Network," *Proc. 31st Chinese Control Decis. Conf. CCDC 2019*, pp. 592–597, Jun. 2019. <https://doi.org/10.1109/CCDC.2019.8832919>
- [6] S. Hadji, F. Krim, and J.P. Gaubert, "Development of an algorithm of maximum power point tracking for photovoltaic systems using genetic algorithms," *7th Int. Work. Syst. Signal Process. their Appl. WoSSPA 2011*, pp. 43–46, 2011. <https://doi.org/10.1109/WOSSPA.2011.5931408>
- [7] S. Salman, X. Ai, and Z. Wu, "Design of a P-&-O algorithm based MPPT charge controller for a stand-alone 200W PV system," *Prot. Control Mod. Power Syst.*, vol. 3, no. 1, pp. 1–8, Dec. 2018. <https://doi.org/10.1186/s41601-018-0099-8>
- [8] S.K. Sahoo, M. Balamurugan, S. Anurag, R. Kumar, and V. Priya, "Maximum power point tracking for PV panels using ant colony optimization," *2017 Innov. Power Adv. Comput. Technol. i-PACT 2017*, vol. 2017-January, pp. 1–4, Jan. 2017. <https://doi.org/10.1109/IPACT.2017.8245004>
- [9] S.K. Saha and Jaipal, "Optimization technique based fuzzy logic controller for MPPT of solar PV system," *2018 Int. Conf. Emerg. Trends Innov. Eng. Technol. Res. ICETIETR 2018*, Nov. 2018. <https://doi.org/10.1109/ICETIETR.2018.8529078>
- [10] H. Salmi, A. Badri, and M. Zegrafi, "Maximum Power Point Tracking (MPPT) Using Artificial Bee Colony Based Algorithm for Photovoltaic System," <http://www.sciencepublishinggroup.com>, vol. 5, no. 1, p. 1, 2016. <http://dx.doi.org/10.11648/j.ijis.20160501.11>
- [11] J. Khanan and S.Y. Foo, "Neural Networks Technique for Maximum Power Point Tracking of Photovoltaic Array," *Conf. Proc. - IEEE SOUTHEASTCON*, vol. 2018-April, Oct. 2018. <https://doi.org/10.1109/SECON.2018.8479054>
- [12] N.A. Windarko, A. Tjahjono, D.O. Anggriawan, and M. H. Purnomo, "Maximum power point tracking of photovoltaic system using adaptive modified firefly algorithm," *Proc. - 2015 Int. Electron. Symp. Emerg. Technol. Electron. Information, IES 2015*, pp. 31–35, Jan. 2016. <https://doi.org/10.1109/ELECSYM.2015.7380809>
- [13] L. Nie, M. Mao, Y. Wan, L. Cui, L. Zhou, and Q. Zhang, "Maximum power point tracking control based on modified abc algorithm for shaded PV system," *2019 AEIT Int. Conf. Electr. Electron. Technol. Automotive, AEIT Automot. 2019*, Jul. 2019. <https://doi.org/10.23919/EETA.2019.8804525>
- [14] D.S. Yanaratri, L.P. SR, I. Ferdiansyah, and R.P. Eviningsih, "Desain dan Implementasi MPPT PSO pada Sistem Pembangkit Listrik Tenaga," *JTT (Jurnal Teknol. Terpadu)*, vol. 9, no. 1, pp. 34–43, Apr. 2021. <https://doi.org/10.32487/jt.v9i1.964>
- [15] P. Megantoro, Y.D. Nugroho, F. Anggara, A. Pakha, and B.A. Pramudita, "The implementation of genetic algorithm to MPPT technique in a DC/DC buck converter under partial shading condition," *Proc. - 2018 3rd Int. Conf. Inf. Technol. Inf. Syst. Electr. Eng. ICITISEE 2018*, pp. 308–312, Jul. 2018. <https://doi.org/10.1109/ICITISEE.2018.8721005>
- [16] M. Orellana, S. Petibon, B. Estibals, and C. Alonso, "Four Switch Buck-Boost converter for Photovoltaic DC-DC power applications," *IECON Proc. (Industrial Electron. Conf.)*, pp. 469–474, 2010. <https://doi.org/10.1109/IECON.2010.5674983>
- [17] R.G. Suryavanshi, S.R. Suryavanshi, D. R. Joshi, and R. B. Magadam, "Maximum power point tracking of SPV at varying atmospheric condition using Genetic Algorithm," *Int. Conf. Energy Syst. Appl. ICESA 2015*, pp. 415–419, Jul. 2016. <https://doi.org/10.1109/ICESA.2015.7503382>
- [18] I. Ferdiansyah, Sutedjo, O. A. Qudsi, and A. Noer Ramadhan, "Implementation of maximum power point tracking on solar panels using cuckoo search algorithm method," *Proc. ICAITI 2019 - 2nd Int. Conf. Appl. Inf. Technol. Innov. Explor. Futur. Technol. Appl. Inf. Technol. Innov.*, pp. 88–92, Sep. 2019. <https://doi.org/10.1109/ICAITI48442.2019.8982163>
- [19] H.A. Mohamed, H.A. Khattab, A. Mobarka, and G.A. Morsy, "Design, control and performance analysis of DC-DC boost converter for stand-alone PV system," *2016 18th Int. Middle-East Power Syst. Conf. MEPCON 2016 - Proc.*, pp. 101–106, Jan. 2017. <https://doi.org/10.1109/MEPCON.2016.7836878>
- [20] "(13) (PDF) DC-DC boost converter design for solar electric system." (accessed Dec. 28, 2022).
- [21] P. Sahu, D. Verma, and S. Nema, "Physical design and modelling of boost converter for maximum power point tracking in solar PV systems," *Int. Conf. Electr. Power Energy Syst. ICEPES 2016*, pp. 10–15, May 2017. <https://doi.org/10.1109/ICEPES.2016.7915898>
- [22] M.A. Sahnoun, H.M.R. Ugalde, J.C. Camona, and J. Gomand, "Maximum Power point Tracking Using P&O Control Optimized by a Neural Network Approach: A Good Compromise between Accuracy and Complexity," *Energy Procedia*, vol. 42, pp. 650–659, Jan. 2013. <https://doi.org/10.1016/j.egypro.2013.11.067>
- [23] V. V. and V. S. R. R., "Microcontroller based bidirectional buck-boost converter for photo-voltaic power plant," *J. Electr. Syst. Inf. Technol.*, vol. 5, no. 3, pp. 745–758, Dec. 2018. <https://doi.org/10.1016/j.jesit.2017.04.002>
- [24] K.K. Pandey, M. Kumar, A. Kumari, and J. Kumar, "Bidirectional DC-DC Buck-Boost Converter for Battery Energy Storage System and PV Panel," *Smart Innov. Syst. Technol.*, vol. 206, pp. 681–693, 2021. [http://dx.doi.org/10.1007/978-981-15-9829-6\\_54](http://dx.doi.org/10.1007/978-981-15-9829-6_54)
- [25] D. Mohapatra, S. Padhee, and J. Jena, "Design of Solar Powered Battery Charger: An Experimental Verification," *2018 IEEE Int. Students' Conf. Electr. Electron. Comput. Sci. SCEES 2018*, Nov. 2018. <https://doi.org/10.1109/SCEES.2018.8546929>
- [26] K.H. Chao and M.N. Rizal, "A Hybrid MPPT Controller Based on the Genetic Algorithm and Ant Colony Optimization for Photovoltaic Systems under Partially Shaded Conditions," *Energies 2021, Vol. 14, Page 2902*, vol. 14, no. 10, p. 2902, May 2021. <https://doi.org/10.3390/en14102902>
- [27] M.S. Bouakkaz et al., "Global Maximum Power Point Tracking Using Genetic Algorithm Combined with PSO Tuned PID Controller," *Lect. Notes Networks Syst.*, vol. 211 LNNS, pp. 1171–1180, 2021. [http://dx.doi.org/10.1007/978-3-030-73882-2\\_107](http://dx.doi.org/10.1007/978-3-030-73882-2_107)
- [28] S. Hadji, J.P. Gaubert, and F. Krim, "Real-Time Genetic Algorithms-Based MPPT: Study and Comparison (Theoretical and Experimental) with Conventional Methods," *Energies 2018, Vol. 11, Page 459*, vol. 11, no. 2, p. 459, Feb. 2018. <https://doi.org/10.3390/en11020459>
- [29] M. Lasheen, A.K.A. Rahman, M. Abdel-Salam, and S. Ookawara, "Performance Enhancement of Constant Voltage Based MPPT for Photovoltaic Applications Using Genetic Algorithm," *Energy Procedia*, vol. 100, pp. 217–222, Nov. 2016. <https://doi.org/10.1016/j.egypro.2016.10.168>

# Buck-boost Converter using GA-based MPPT for Solar Energy Optimization

## ORIGINALITY REPORT

16%

SIMILARITY INDEX

12%

INTERNET SOURCES

7%

PUBLICATIONS

5%

STUDENT PAPERS

## PRIMARY SOURCES

1	<a href="http://www.researchgate.net">www.researchgate.net</a> Internet Source	5%
2	Submitted to University of Portsmouth Student Paper	1%
3	<a href="http://scholar.ppu.edu">scholar.ppu.edu</a> Internet Source	1%
4	Submitted to University of Bolton Student Paper	1%
5	<a href="http://file.umj.ac.id">file.umj.ac.id</a> Internet Source	1%
6	Guiqiang Li, Yi Jin, M.W. Akram, Xiao Chen, Jie Ji. "Application of bio-inspired algorithms in maximum power point tracking for PV systems under partial shading conditions – A review", Renewable and Sustainable Energy Reviews, 2018 Publication	1%
7	Abdelghani Harrag, Sabir Messalti. "Variable step size modified P&O MPPT algorithm using	<1%

# GA-based hybrid offline/online PID controller", Renewable and Sustainable Energy Reviews, 2015

Publication

8

"Smart Grids and Green Energy Systems", Wiley, 2022

Publication

<1 %

9

Submitted to University of Greenwich

Student Paper

<1 %

10

documents.mx

Internet Source

<1 %

11

www.coursehero.com

Internet Source

<1 %

12

Submitted to University of Cape Town

Student Paper

<1 %

13

academic.hep.com.cn

Internet Source

<1 %

14

hackaday.io

Internet Source

<1 %

15

link.springer.com

Internet Source

<1 %

16

R. Madhana, M. Geetha. "Power Enhancement Methods of Renewable Energy Resources using Multiport DC-DC Converter: A Technical Review", Sustainable Computing: Informatics and Systems, 2022

<1 %

- 
- 17 [etd.lib.metu.edu.tr](http://etd.lib.metu.edu.tr) Internet Source <1 %
- 
- 18 [ijrer.ijrer.org](http://ijrer.ijrer.org) Internet Source <1 %
- 
- 19 [scholarcommons.sc.edu](http://scholarcommons.sc.edu) Internet Source <1 %
- 
- 20 [9dok.org](http://9dok.org) Internet Source <1 %
- 
- 21 A. Narendra, N. Venkataramana Naik, Anup Kumar Panda, Nishit Tiwary. "A Comprehensive Review of PV Driven Electrical Motors", Solar Energy, 2020  
Publication <1 %
- 
- 22 Kit Guan Lim, Mohd Izzat Fikri Md Zainal, Min Keng Tan, Ahmad Razani Haron, Chang Yii Chai, Kenneth Tze Kin Teo. "Adapting Perturbation Voltage For Variable Speed Micro-Hydro Using Particle Swarm Optimization (PSO)", 2022 IEEE International Conference on Artificial Intelligence in Engineering and Technology (IICAIET), 2022  
Publication <1 %
- 
- 23 Murat Mustafa Savrun, Mustafa İnci. "Adaptive neuro-fuzzy inference system combined with genetic algorithm to improve power extraction capability in fuel cell <1 %

applications", Journal of Cleaner Production,  
2021

Publication

24

Sabrina Titri, Cherif Larbes, Kamal Youcef Toumi, Karima Benatchba. "A new MPPT controller based on the Ant colony optimization algorithm for Photovoltaic systems under partial shading conditions", Applied Soft Computing, 2017

Publication

<1 %

25

[honors.libraries.psu.edu](https://honors.libraries.psu.edu)

Internet Source

<1 %

26

[ijeces.ferit.hr](https://ijeces.ferit.hr)

Internet Source

<1 %

27

[journal.uokufa.edu.iq](https://journal.uokufa.edu.iq)

Internet Source

<1 %

28

[riunet.upv.es](https://riunet.upv.es)

Internet Source

<1 %

29

[www.praiseworthyprize.org](https://www.praiseworthyprize.org)

Internet Source

<1 %

30

Zubayer Alam Khan, Shoayeb Fahim Akhter, Sakib Islam, Fahim Abid. "A Golden Eagle Optimization Based MPPT Control For Partial Shading Conditions", 2022 IEEE International Conference on Power Electronics, Smart Grid, and Renewable Energy (PESGRE), 2022

Publication

<1 %

---

Exclude quotes Off

Exclude matches Off

Exclude bibliography On