



Naskah Publikasi

Irfan Syafaah Ariyanto Faruq - permanent magnet generator turbine energy

 Irfan Syafaah Ariyanto Faruq - permanent magnet generator turbine energy

 Teknik Elektro

 University of Muhammadiyah Malang

Document Details

Submission ID

trn:oid::1:2996717837

Submission Date

Sep 3, 2024, 12:58 PM GMT+7

Download Date

Sep 3, 2024, 1:01 PM GMT+7

File Name

h_Ariyanto_Faruq_-_permanent_magnet_generator_turbine_energy.pdf

File Size

1.4 MB

9 Pages

3,264 Words

16,123 Characters

20% Overall Similarity

The combined total of all matches, including overlapping sources, for each database.





Filtered from the Report

- ▶ Bibliography
- ▶ Quoted Text



Exclusions

- ▶ 21 Excluded Matches

Match Groups

-  **4 Not Cited or Quoted 20%**
Matches with neither in-text citation nor quotation marks
-  **0 Missing Quotations 0%**
Matches that are still very similar to source material
-  **0 Missing Citation 0%**
Matches that have quotation marks, but no in-text citation
-  **0 Cited and Quoted 0%**
Matches with in-text citation present, but no quotation marks

Top Sources

- 20%  Internet sources
- 21%  Publications
- 12%  Submitted works (Student Papers)

Integrity Flags

0 Integrity Flags for Review

No suspicious text manipulations found.

Our system's algorithms look deeply at a document for any inconsistencies that would set it apart from a normal submission. If we notice something strange, we flag it for you to review.

A Flag is not necessarily an indicator of a problem. However, we'd recommend you focus your attention there for further review.

Match Groups

- 4 **Not Cited or Quoted 20%**
 Matches with neither in-text citation nor quotation marks
- 0 **Missing Quotations 0%**
 Matches that are still very similar to source material
- 0 **Missing Citation 0%**
 Matches that have quotation marks, but no in-text citation
- 0 **Cited and Quoted 0%**
 Matches with in-text citation present, but no quotation marks

Top Sources

- 20% Internet sources
- 21% Publications
- 12% Submitted works (Student Papers)

Top Sources

The sources with the highest number of matches within the submission. Overlapping sources will not be displayed.

- 1

Publication

M Irfan, R F Ariyanto, L Syafaah, A Faruq, Nurhadi, N Subeki. "Stator slotted desig... 12%

- 2

Student papers

Universitas Muhammadiyah Purwokerto 7%

- 3

Publication

V G Gribin, A A Tishchenko, R A Alekseev, I Yu Gavrilov, V V Popov, V A Tishchenko.... 2%

PAPER • OPEN ACCESS

Stator slotted design of axial flux permanent magnet generator for low-speed turbine

3 To cite this article: M Irfan *et al* 2020 *IOP Conf. Ser.: Mater. Sci. Eng.* **821** 012027

View the [article online](#) for updates and enhancements.

You may also like

- [High-frequency electric field intensity sensor based on double-slot waveguides filled with electro-optical polymer](#)
I.A. Goncharenko and V.N. Ryabtsev
- [Axial laser beam cleaning of tiny particles on narrow slot sidewalls](#)
Liyang Yue, Zengbo Wang, Wei Guo *et al.*
- [Development of helical, fish-inspired cross-step filter for collecting harmful algae](#)
Adam Schroeder, Lauren Marshall, Brian Trease *et al.*



PRIME
PACIFIC RIM MEETING
ON ELECTROCHEMICAL
AND SOLID STATE SCIENCE
HONOLULU, HI
October 6-11, 2024

Joint International Meeting of
The Electrochemical Society of Japan (ECSJ)
The Korean Electrochemical Society (KECS)
The Electrochemical Society (ECS)

Early Registration Deadline:
September 3, 2024

**MAKE YOUR PLANS
NOW!**

Stator slotted design of axial flux permanent magnet generator for low-speed turbine

M Irfan*, R F Ariyanto, L Syafaah, A Faruq, Nurhadi, and N Subeki

Department of Electrical Engineering, Faculty of Engineering, Universitas Muhammadiyah Malang, Malang, Indonesia

*Email: irfan@umm.ac.id

Abstract. The wind power plant has an important component, namely a generator which is an electrical engine that converts mechanical energy into electrical energy. This paper discusses the design of the permanent rotor axial flux generator (Single Rotor Single Stator) using a slotted stator and using a slotted stator reference design. To find out more in detail, this work was conducted by comparing four different generator designs, the number of slots and tooth widths. Testing the width of the teeth and the number of slots varied, including 12 slots width of teeth 23 mm, 15 slots width of teeth 18 mm, and 18 slots width of teeth 15 mm. The permanent magnet used in this study is neodymium iron boron, NdFeB 48/11 with a total of 10 poles. The desired reference power is 100 Watt with a speed of 500 Rpm. The outputs of each design in the form of voltage, current, power, and efficiency are discussed. The conclusion obtained that the additional teeth to the stator and increasing the number of axial flux slots affect the specified output parameters. The result of using teeth is that the voltage, current, and power are getting bigger and the more number of slots the smaller the voltage, current, and power.

1. Introduction

Increasing energy needs encourage us to look for alternative energy sources. At present most of the energy produced uses fossil fuels that can cause global warming. In addition, the amount of fossil fuels available is limited. To overcome the problem of global warming and to meet energy demand, renewable energy sources are targeted as alternative energy. Wind energy is a very productive renewable energy source. Abundant wind to exploit the potential of this renewable source.

An electric machine is a device that can convert mechanical energy into electrical energy or electrical energy into mechanics. When such a device is used to condition mechanical energy to electrical energy, it is called a generator. When converting electrical energy into mechanical energy, it is called a motor. Because every electric engine supplied can convert power in one direction, each machine can be used as both a generator and a motor. Almost all motors and generators practically convert energy from one form to another through the action of the magnetic field.

Min-Fu Hsieh et al [1] conducted a study on reducing cogging torque in axial flux machines for wind turbines by changing the direction of the slot and changing the slope of the magnet. In this study using the finite element model. From the results of this study that by changing the direction of the slot and the slope of the magnet can reduce peak cogging torque by 88% compared to not changing the magnetic slope. This shows the method to be effective and able to reduce cogging torque to a much lower level.



Content from this work may be used under the terms of the [Creative Commons Attribution 3.0 licence](https://creativecommons.org/licenses/by/3.0/). Any further distribution of this work must maintain attribution to the author(s) and the title of the work, journal citation and DOI.

J.G. Wanjiku et al [2] conducted research on minimizing torque cogging in PMSG flux axial with the parallel stator. Permanent magnets with slot-less stators can eliminate hysteresis and cogging torque losses, but greater eddy current losses. In this study using finite element analysis. The results of this study effectively reduce cogging torque by around 70% while reducing skewing by around 50%. Both methods show minimal effects on machine work. Gyeong-Chan Lee et al [3] conducted research on the design of dual structural permanent magnet generators for wind turbines. In this study to reduce cogging torque slotted flux axial permanent magnet generators, where the rotor is clamped with two stators. From the results of this study, the permanent magnet is tilted and the design of the slot transfer can be as high as 1.3 kW and the cogging torque is below 1.61%.

Ionut Bogdan Stoenescu et al [4] conducted a study of simulations of a flux axial magnet synchronous generator under no-load conditions. From the results of this study that the simulation results from phase to phase are far from reality, due to the distribution of magnetic flux in the coil and magnetic flux produced by magnets is not sinusoidal. Wearing teeth is very important because the heat dissipation from stator friction with a magnet that causes heat can be flowed to the teeth and divided into all slots that are on the stator, but when not using a slot then the heat caused by friction will collect on the stator. From the accumulation of heat, there will be a very high eddy current.

From some of the mentioned studies it can be concluded that the slotted stator on the axial flux generator is needed for excessive heat dissipation when the generator is operating at its maximum. In small scale axial flux generators do not use slots, but for larger-scale will definitely use. Therefore teeth need to be made on the stator so that the generator design obtained is the optimal design. In this work the teeth will be made on the axial flux generator using slots and poles totaling 12 10-pole slots, 15 10-pole slots, and 18 10-pole slots. The analysis is done by using the formula calculation using finite element. The software used for the finite element method (FEM) analysis simulation is MagNet Infolytica software [5, 6].

2. Methodology

Modeling and simulation are the methods used to model and simulate the model to see whether the model gives results that are in accordance with what is desired. With modeling and simulation, research larger-scale can be done more effectively. This work is about modeling 4 axial flux generator designs namely, permanent magnet generator axial flux 15 slots-10 poles single rotor-single stator (SR-SS) model with resin, 12 slots-10 poles single rotor-single stator (SR-SS), 15 slots-10 single rotor-single stator poles (SR-SS) and 18 slots-10 single rotor-single stator poles (SR-SS). This generator model is made with the same specifications and material then simulated at different rotational speeds. The output of the model is compared with the magnetic flux, voltage, current, power and efficiency so that the most optimal design can be produced.

This paper discusses the analysis of the maximum magnetic field strength with MagNet Infolytica software [5, 6] and compares the results of the calculations and the output voltage will be calculated on the MPAF generator. The type of core laminated material chosen must be classified as a type of soft magnetic material, which means that the material chosen will only be magnetic when there is a magnetic field about it. The type chosen in this research is the type of silicon steel. The content of silicon in silicon steel materials ranges from 0.5% - 3.25%. The core laminate used in the generator design is M250-50A steel type silicon iron with a thickness of 0.5 mm. The types of magnetic properties of the material can be seen in Table 1. The flow of magnetic flux through the material must be maintained so as not to exceed the saturation point.

The permanent magnet material used is NdFeb type NdFeb 48/11 [7, 8]. The selection of magnetic material is based on previous research. The standard used is the Chinese standard with the magnetic characteristics shown in Table 2. The type of coil material used is Copper: $5.77e7$ Siemens / m with characteristics as shown in Table 3. This type of material is very often used because it has a high conductivity value. In this axial flux permanent magnet generator design, there are several parameters that have been previously known. These parameters refer to references [9, 10], as shown in Table 4.

Table 1. Magnetic propertis type M250-50A material

Parameters and Symbols	Value	Unit
1,5 T	2,38	W/kg
1,0 T	1,02	W/kg
Anisotropy of loss	10	%
2.500 A/m	1,55	Tesla
5.000 A/m	1,64	Tesla
10.000 A/m	1,77	Tesla
Coactivity (DC)	30	A/m
Relative permeability at 1,5 T	740	-

Table 2. Characteristics of NdFeb Magnets 48/11

Parameters and Symbols	Value	Unit
Remanence flux density	1,39	T
Coercive force, H_{cb}	1060650	Oe (A/m)
Intrinsic Coercive Force, H_{cj}	11,0 (876)	kOe (kA/m)
Energy Product, BH_{max}	50-53 (398-422)	MGO (KJ/m ³)
Max. Operating Temp.	20	°C

Table 3. Copper Characteristics: Siemens 5.77e7 / m

Parameters	Value	Unit
Conductivity	57700000	M
Thermal Conductivity	386	W/m.C
Thermal Specific	383.1	J/Kg.C
Density	8954	Kg/m ³
Max. Operating temp	20	°C

Table 4. Mathematical Equation Parameters [9]

Parameters	Dimension
Daya	100 watt
Cosφ	0,8
Efficiency (η)	90%
$V_1 = 380/\sqrt{3}$	220
$\epsilon = E_t/V_1$	2
B_{mg}	0,65 T
A_m	22000 A/m
G_t	0.55
G_c	0.55
K_{w1}	0,96
K_D	0,131
J_a	$4,5 \times 10^6$ A/m ²

To get simulation data in the form of no-load voltage, voltage with load, current, and power, it is necessary to make a circuit so that the data can be generated. In this series is a series of three phases, each phase is connected with Wye-Connection with each phase composed of 4, 5, and 6 coils arranged in series. As for simulations with loads, an additional circuit is needed in the form of a diode that serves to rectify waves at each phase, and obstacles in the form of resistors that function as loads. The

value of the resistor used varies from 5 Ohms, 10 Ohms, and 15 Ohms. Display a simulation circuit with a load as shown in Figure 1 and Figure 2.

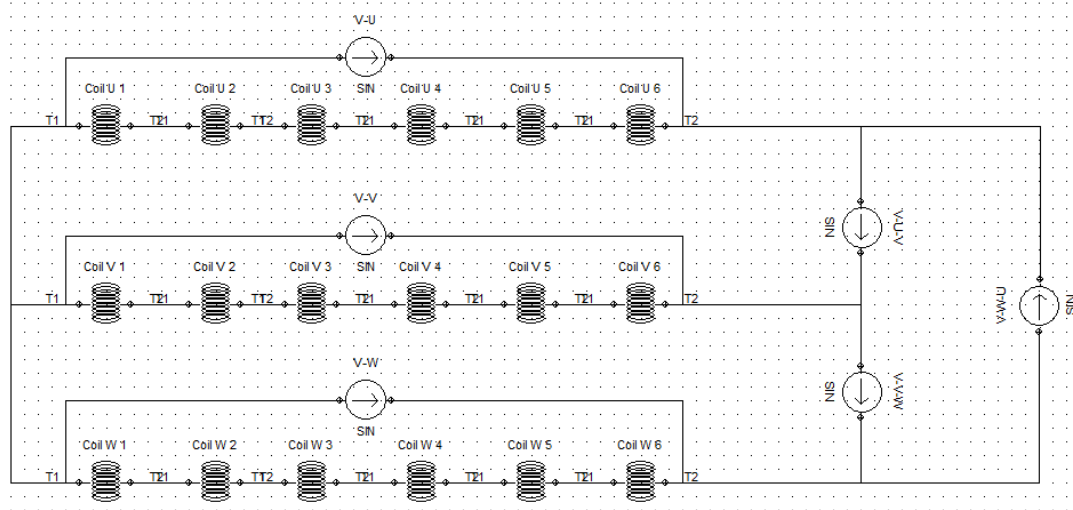

Figure 1. Schematic simulation design without load for 18 slots

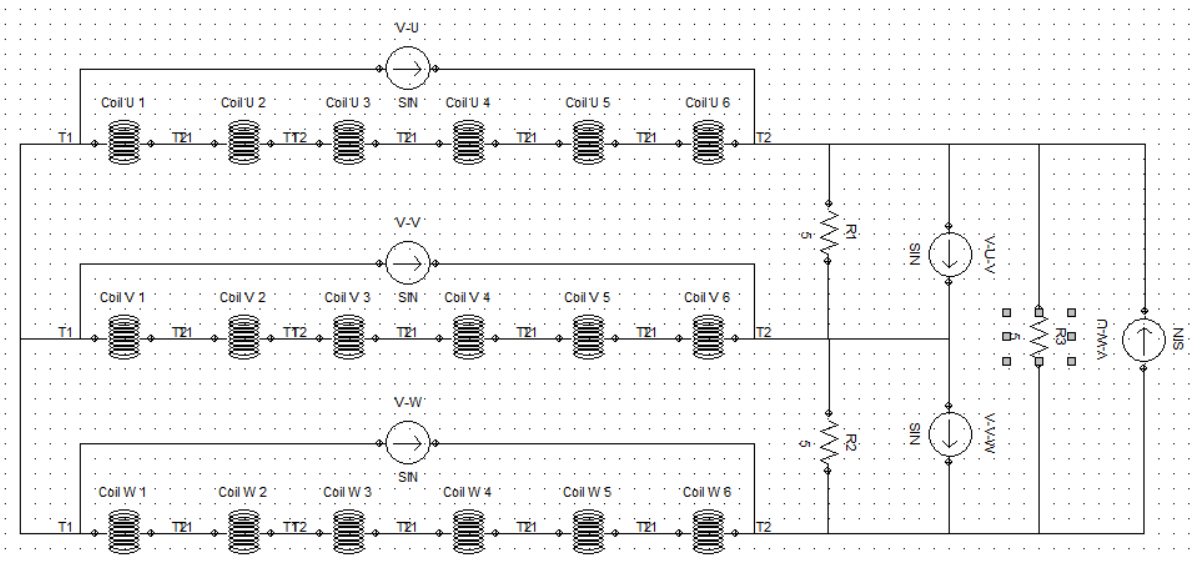

Figure 2. Schematic simulation design 18 slots with load of 15 Ohm

3. Result and discussions

This section discusses data analysis from simulation results carried out using MagNet Infolytica software. Also in this section discusses the comparison of the results of 4 model simulations. Data obtained from the MagNet Infolytica software is analyzed. The following parameters obtained from the calculation results are outlined in Table 5.

Table 5. Calculation result of dimension generator

Variable Components	Setting value
Stator diameter outside (D_{out})	220 mm
Stator diameter inside (D_{in})	100 mm
Airgap width (lg)	3 mm
Rotor outer diameter (D_i)	220 mm
Rotor inside diameter (D_a)	100 mm
Magnetic Thickness (L_m)	3 mm
Slotted width (b_t)	23 mm (12 slot) / 18 mm (15 slot) / 15 mm (18 slot)
Slotted length (h_s)	20 mm
Stator thick yoke (h_y)	8 mm
Total of Slots (N_s)	12 slot / 15 slot / 18 slot
Total of Pole (p)	10 pole
Number of coil each teeth	170 turns (12 slot) / 134 turns (15 slot) / 112 turns (18 slot)
Stator and Rotor Core Materials	M250 – 50A
Permanent Magnet Material	NdFeb 48./11
Coil materials	Copper : 5.77e7 Siemens/m

All models were simulated and compared to determine the effect of changes in the slotted stator and the number of slots on the output of the AFPM design. After comparing each model. Output compared is in the form of no-load current and output power. As for the selection of the model parameters used are the current limit and output power, for consideration. The data being compared is the *Rms* voltage data for each model, in this section the data shown is only comparative data at a speed of 700 Rpm. To facilitate analysis, you can see in Figure 3.

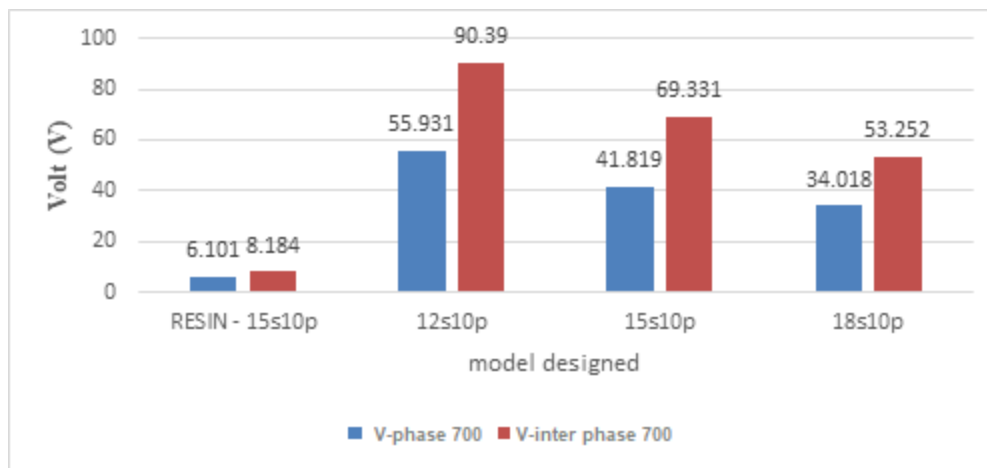

Figure 3. Inter Phase Phase *Rms* Voltage and phase *Rms* Voltage each model at 700 Rpm speed

From the table and graph above, it can be noted that the difference between the slotted 15S10P model and the slotless 15S10P model produced by the output voltage has increased very significantly, it can be seen the results of the 15S10P shoeless with a voltage of 6,101 V for the 15S10P slotted with a voltage of 41,819 V. , and 18 slots reduce the large output voltage of the generator design, the pattern is seen in the models with the number of slots 12, 15 and 18. If observed thoroughly, the 12S10P model at 700 Rpm speeds produces the largest output voltage compared to models 15 and 18 slots.

3.1. Comparison of output power for each model

The data being compared is the simulation data with a speed of 700 Rpm at a load of 15 Ohms. Data of each model is presented in graphical form to facilitate analysis. Comparison data can be seen in Figure 4.

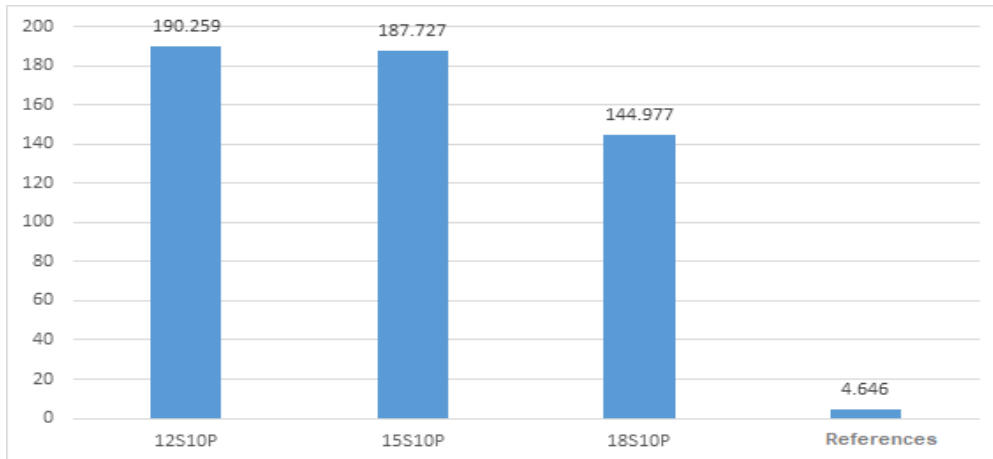
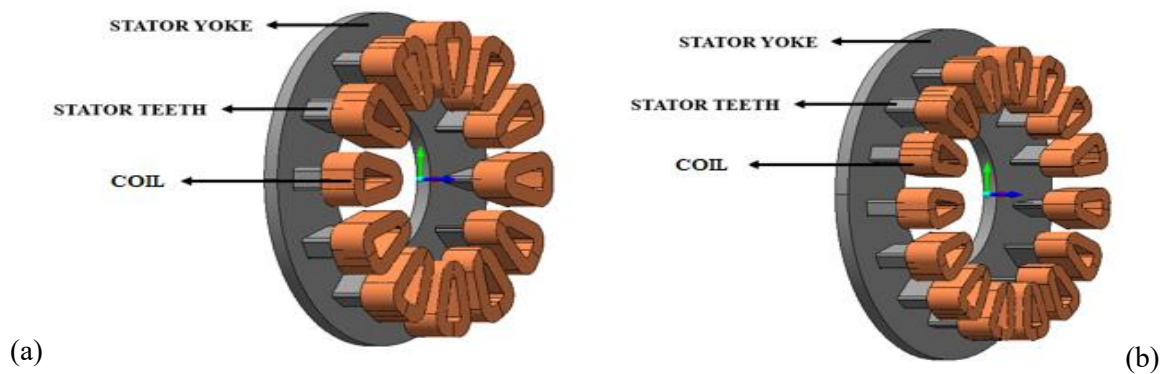
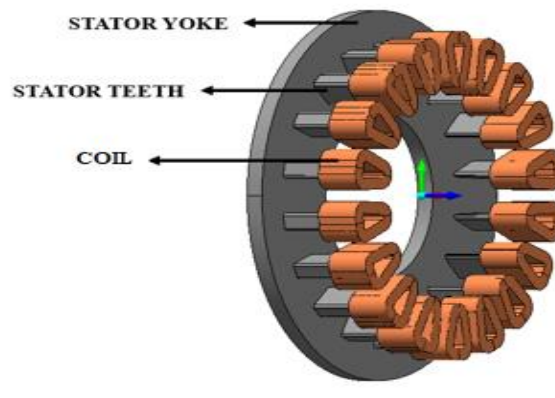

Figure 4. The output power of each model at a speed of 700 Rpm and a load of 15 Ohms

From the Figure 4, it can be seen that the largest output power is owned by the 12S10P model with an output power of 190,259 Watt, while the smallest output power is generated by the 15S10P model with resin with an output power of 4,646 Watt. The comparison of 15S10P slotted and 15S10P slotless output power increased significantly for the 15S10P slotted model. For comparison between the number of slots can be seen from the results of the above simulation that the number of slots with the same number of poles, the less power generated will be generated. Overall designed slotted stator in this study as it demonstrated in Figure 5.





(c)

Figure 5. Designed permanent magnet generator. (a). Model 12S10P Stator *Slotted*. (b). Model 15S10P Stator *Slotted*. (c). Model 18S10P Stator *Slotted*

4. Conclusions

The design of axial flux permanent magnet generators at different speeds and loads, it can be concluded that the increase in speed in each model has an effect perpendicular to the generated voltage. The faster the rotation the greater the voltage generated. The number of slots has effect to determine the width of the slotted stator. The more the number of slots, the smaller the width of the slotted. Seen from the calculations for each slot, the difference in size is obtained when the 12 model slots measure 23 mm, for the 15 slot model the size is 18 mm, and for 18 slots the size is 15 mm.

Comparison of the slot-less 15S10P and 15S10P reference models where the output voltage, current and power are very different, the results of the 15S10P slotted are greatly increased compared to the slot-less 15S10P. Due to the losses in the slot-less 15S10P model so the results are not too large as the slotted 15S10P model. Whereas the efficiency of slot-less 15S10P is greater than the slotted model. For comparison of the number of different slots and the same number of poles the results obtained from the simulation for voltage, current, and power decrease but for increased efficiency.

Further developments that can be carried out include: Analyze the effect of the stator slotted on cogging torque and torque ripple. Developing a slotted stator with multi-stator and multi-rotor. And varying with different materials on cores and magnets.

Acknowledgement

The authors wish to express their gratitude to the Faculty of Engineering, Universitas Muhammmadiyah Malang, and Direktorat Penelitian dan Pengabdian Masyarakat (DPPM) for supporting this work.

References

- [1] Hsieh M, Dorrell D G, Yeh Y and Ekram S 2009 Cogging torque reduction in axial flux machines for small wind turbines in *2009 35th Annual Conference of IEEE Industrial Electronics* pp 4435-39.
- [2] Wanjiku J G, Member S, Jagau H, Member S, Khan M A and Barendse P S 2011 Minimization of cogging torque in a small axial- Flux PMSG with a parallel-teeth stator in *2011 IEEE Energy Conversion Congress and Exposition* pp 3687-93.
- [3] Lee G 2013 Design of dual structural axial flux permanent magnet generator for small wind turbine in *IEEE 2013 Tencon - Spring* pp 90-4.
- [4] Stoenescu I B, Costinas S and Chicco G 2014 The simulation of an axial-flux permanent magnet synchronous generator in no-load condition in *2014 16th International Conference on Harmonics and Quality of Power (ICHQP)* pp 375-9.
- [5] Anam M C, Irfan M and Nurhadi 2017 Perancangan generator 100 watt menggunakan software elektromagnetik infolityca *Kinet. Game Technol. Inf. Syst. Comput. Network, Comput.*

- Electron. Control* vol **2**(1) pp 27–36.
- [6] Yusuf A A and Irfan M 2018 A design of coreless permanent magnet axial flux generator for low speed wind turbine in *2018 5th International Conference on Electrical Engineering, Computer Science and Informatics (EECSI)* pp 637–41.
- [7] Irfan M, Effendy M, Suhardi S and Pakaya I 2018 A design of electrical permanent magnet generator for rural area wind a design of electrical permanent magnet generator for rural area *Int. J. Power Electron. Drive Syst.* vol **9**(1) pp 269–75.
- [8] Irfan M, Hakim E, Suhardi D, Kasan N, Faruq A and Anam M 2018 Simplified design of low speed electric permanent magnet generator for small wind power plant *IOP Conf. Ser. Mater. Sci. Eng.* vol **403** pp 1–6.
- [9] Gieras J F, Rong-Jie W and Kamper M J 2005 *Axial Flux Permanent Magnet Brushless Machines* (New York: Kluwer Academic Publishers).
- [10] Messina G, De Bella E T, and Morici L 2019 HTS axial flux permanent magnets electrical machine prototype: Design and test results *IEEE Trans. Appl. Supercond.* vol **29**(2) pp 1–5.